

POSTAL[®]

STEEL GROUP



KATALOG
2014 - 2016



POSTAL[®]

STEEL GROUP

POSTAL STEEL GROUP Sp. z o.o. Sp. k.

CENTRALA

ul. Sowia 6 | „Sowia” Park Przemysłowy
62-080 Tarnowo Podgórne
POLAND

T: +48 61 65 25 900
F: +48 61 816 80 80
zamowienia@postal.pl

ODDZIAŁ ŚLĄSK

ul. Gliwicka 17 C
44-178 Przyszowice k. Gliwic

T: +48 32 230 28 42
F: +48 32 230 28 43
slask@postal.pl

ODDZIAŁ RADOM

ul. Chorzowska 14
26-600 Radom

T: +48 48 66 35 778
F: +48 48 36 51 283
radom@postal.pl

POSTAL CZ s.r.o.

Přepeře 227
512 61 Přepeře u Turnova
Česká republika

T: +420 481 313 093
M: +420 602 252 146
info@postalcz.cz
www.postalcz.cz

POSTAL SK s.r.o.

Dunajska 52
811 08 Bratislava
Slovensko

T: +421 482 601 099
kontakt@postalsk.sk
www.postalsk.sk

www.postal.pl



Stalowe elementy kute do bram, ogrodzeń i balustrad Steel forged components

1.01	elementy spiralne • scrolls • Spiralelemente • спиральные элементы • spirálové elementy	10
1.02	koszyki • baskets • Körbe • корзины • košíky	16
1.03	rozety • rosettes • Rosetten • розетки • rozety	17
1.04	tralki i słupy • balusters and baluster posts • Stäbe und Brüstungspfosten • балясины • tyčky a sloupky	33
1.05	płaskowniki • flat bars • Flachstangen • полосы • ploché tyče	43
1.06	taśmy • banding materials • Bände • ленты • pásoviny	49
1.07	pręty ozdobne • decorative bars • dekorative Stäbe • декоративные прутья • tyče ozdobné	51
1.08	profile zamknięte • bars • verikant Rohre • прутья • tyče průvlakové	52
1.09	groty • spears • Spitzen • пики • hroty	53
1.10	przekuwki • slugs • Rohraufsätze • насадки • návleky	59
1.11	gałki • knobs • Knöpfe • набалдашники • šišky	60
1.12	kule • spheres • Kugeln • шары • koule	61
1.13	maskownice • masking frames • Blenden • маскировочные элементы • zákrytky	63
1.14	kwiaty i liście • flowers and leaves • Blumen und Blätter • цветы и листья • květy a listy	66
1.15	odlewy ze staliwa • cast steel items • Stalguss • литая сталь • odlitky z lité oceli	84
1.16	odlewy z żeliwa • cast iron items • Gusseisenwaren • чугунные элементы • odlitky z litiny	89

Akcesoria do bram, ogrodzeń marki PSG oraz elektronarzędzia Accessories for gates an fences

2.01	wózki i akcesoria • cantilever gate carriages, accessories • Wagen, Zubehör • каретки и аксессуары • vodící vozíky a příslušenství	92
2.02	daszki i zaślepki • post tops and stoppers • Deckel und Verschlusskappen • навесы и заглушки • krytky a záslepky	101
2.03	klamki i szyldy • door handles and shields • Griffe und Schilder • ручки и накладки • kliky a štítky	103
2.04	zamki i wkładki • lock stets and inserts • Türschlösser und Schlosskästen • замки и вкладыши • zámky a vložky	113
2.05	mocowania i wykończenia • fixings and finishing elements • Aufnahmen und Endstücken • крепления и отделки • kotvení a zakončení sloupků	116
2.06	skrzynki • mail boxes • Briefkästen • почтовые ящики • poštovní schránky	121
2.07	lampy • lamps • Lampen • лампы • lampy	123
2.08	farby i patyny • paints and patina • Farben und Edelrost • краски и патины • barvy a patyny	123
2.09	kotwy i akcesoria • anchors and accessories • Anker und Zubehör	125
2.09	elektronarzędzia BOSCH • power tools BOSCH • Kraftwerkzeuge BOSCH • elektronářadí BOSCH	126
2.10	elektronarzędzia DeWalt • power tools DeWalt • Kraftwerkzeuge DeWalt • elektronářadí DeWalt	128

Spawalnictwo – drut spawalniczy, urządzenia i akcesoria Welding

3.01	drut spawalniczy Platinum • welding wire Platinum • Schweißdraht Platinum • svařovací drát Platinum	132
3.02	drut spawalniczy STAR WIRE • welding wire STAR WIRE • Schweißdraht STAR WIRE • svařovací drát STAR WIRE	134
3.03	drut spawalniczy do stali nierdzewnej PINOX • welding wire for stainless steel PINOX • Schweißdraht für Edelstahl PINOX • svařovací drát z nerezové oceli PINOX	136
3.04	akcesoria spawalnicze • welding accessories • Schweißzubehör • svařovací příslušenství	137
3.05	urządzenia spawalnicze ESAB • welding machines ESAB • Schweißgeräte ESAB • svařovací zařízení ESAB	138



Tarcze do cięcia i szlifowania stali Cutting discs

4.01	tarcze STAR FLEX • cutting discs STAR FLEX • Trennscheiben STAR FLEX • kotouče STAR FLEX	142
4.02	tarcze PFERD • cutting discs PFERD • Trennscheiben PFERD • kotouče PFERD	144

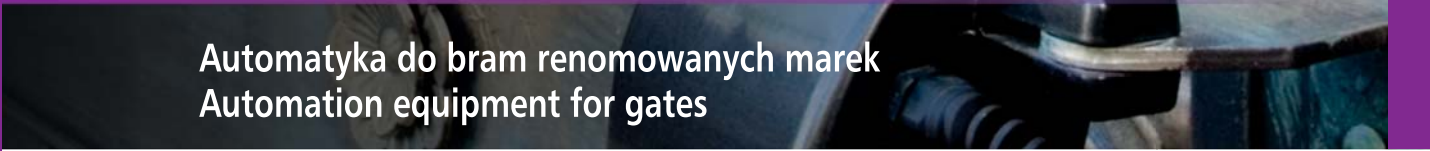

Automatyka do bram renomowanych marek Automation equipment for gates

5.01	automatyka do bram CAME • gate automation systems CAME • Torautomatik CAME • automatické pohony bran CAME ...	146
5.02	automatyka do bram FAAC • gate automation systems FAAC • Torautomatik FAAC • automatické pohony bran FAAC	149



Elementy ze stali nierdzewnej do poręczy i balustrad Inox elements

6.01	uchwyty do szkła • glass clamps	155
6.02	uchwyty przelotowe • crossbar holder	156
6.03	uchwyty do linki • rope holders	157
6.04	uchwyty poręczy • handrail holder	157
6.05	blaszki montażowe poręczy • handrail plates	157
6.06	łączniki słupka • handrail fittings	158
6.07	zaśleпки • tube end plug	159
6.08	łączniki • connectors	159
6.09	kule • balls	160
6.10	pręty uchwyty poręczy • handrail fittings	161
6.11	mocowanie słupka • fastening	161
6.12	łączniki przegubowe • bolt with hinge	161
6.13	zakończenie pręta • endcup of rod	161
6.14	podstawy do słupa • bottom fastenings	162
6.15	maskownice • covers	162
6.16	mocowanie osiowe • wall and bottom fastening	162
6.17	łącznik poprzeczny • handrail fitting	163
6.18	rura ze stali nierdzewnej • inox tube	163
6.19	blaszki • plates	163
6.20	śruby • screws	163
6.21	nakrętki kołpakowe • bolt caps	164
6.22	stalowy łącznik śrubowy • threaded rod	164
6.23	klej anaerobowy • anaerobic glue	164
6.24	tuleja siatkowa	164
6.25	kotwy chemiczne • chemical anchors	164



POSTAL[®]

STEEL GROUP

Firma POSTAL STEEL GROUP działa w branży metalowej od 1992 roku, oferując szeroką gamę stalowych elementów kutych do bram, ogrodzeń, balustrad, poręczy, etc. Zajmujemy się również sprzedażą farb i patyn, automatyk i do bram, materiałów eksploatacyjnych oraz stali nierdzewnej.

W naszym asortymencie znajduje się obecnie ponad 12 000 produktów.

Odbiorcami naszych wyrobów są firmy nie tylko z całej Polski, ale także z wielu państw europejskich.



POSTAL STEEL GROUP company operates in the metal industry since 1992, offering a wide range of steel forged components for gates, fences, balustrades, handrails, etc. Also, we supply paint and patina, automation equipment for gates, tools and supplies and stainless steel. Currently, we have more than 12 000 products in our offer. Our customers are companies, not only from Poland, but also from many European countries.



The company has created a popular brands: cutting discs STAR FLEX, Platinum and STAR WIRE welding wire, POSTAL INOX stainless steel products and PSG suppliers.

The company's regular offer features more than 18 000 articles and is being successively enriched with new products. Our own brands – STAR FLEX cutting and grinding discs, as well as PLATINIUM and STAR WIRE welding wires – are in high demand. Each year the company participates in many international fairs. POSTAL continuously increases the quality of service, offering the products at attractive prices.

Please feel free to contact us!

Firma stworzyła uznane marki produktowe: tarcze STAR FLEX, drut spawalniczy marki Platinum oraz STAR WIRE, materiały eksploatacyjne PSG oraz produkty ze stali nierdzewnej PINOX.

Firma posiada w stałej sprzedaży ponad 18 000 artykułów, sukcesywnie wzbogacając asortyment oferowanych towarów. Dużą popularnością cieszą się produkty jej własnych marek – tarcze do cięcia i szlifowania STAR FLEX, a także drut spawalniczy Platinum oraz STAR WIRE.

Corocznie firma bierze udział w kilkunastu międzynarodowych imprezach targowych.

POSTAL regularnie podnosi jakość obsługi, oferując swoje produkty w atrakcyjnych cenach.

Zapraszamy do kontaktu!

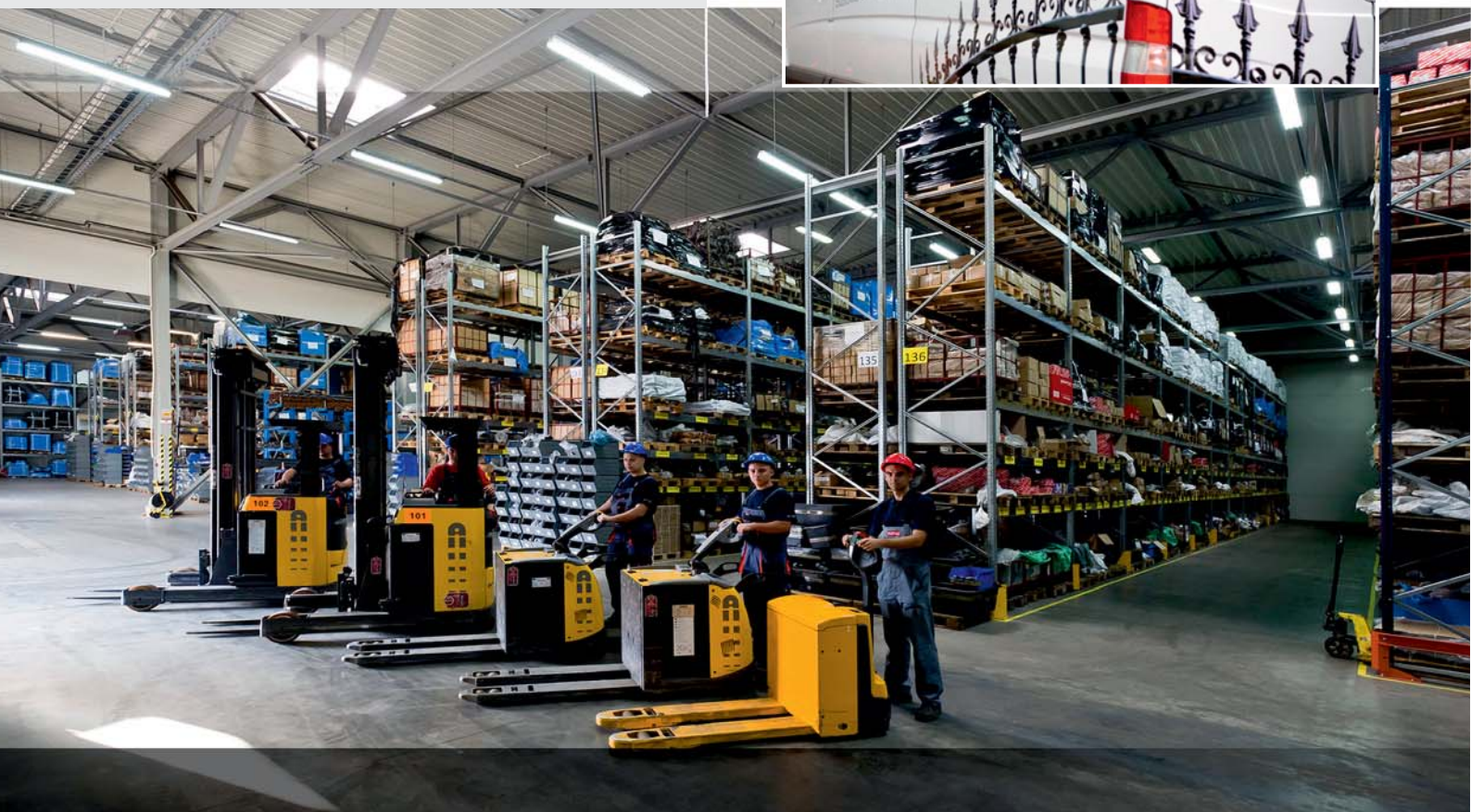

PSG

**STAR
FLEX**

Platinum

**STAR
WIRE**

PINOX

Jesteśmy w całej Europie
We are present in all Europe



POSTAL STEEL GROUP Sp. z o.o. Sp. k.

CENTRALA
ul. Sowie 6 | „Sowia” Park Przemysłowy
62-080 Tarnowo Podgórne
POLAND

T: +48 61 65 25 900
F: +48 61 816 80 80
zamowienia@postal.pl

ODDZIAŁ ŚLĄSK
ul. Gliwicka 17 C
44-178 Przystawice k. Gliwic

T: +48 32 230 28 42
F: +48 32 230 28 43
slask@postal.pl

ODDZIAŁ RADOM
ul. Chorzowska 14
26-600 Radom

T: +48 48 66 35 778
F: +48 48 36 51 283
radom@postal.pl

POSTAL CZ s.r.o.
Přepeře 227
512 61 Přepeře u Turnova
Česká republika

T: +420 481 313 093
M: +420 602 252 146
info@postalcz.cz
www.postalcz.cz

POSTAL SK s.r.o.
Dunajská 52
811 08 Bratislava
Slovensko

T: +421 482 601 099
kontakt@postalsk.sk
www.postalsk.sk

www.postal.pl



Każdego roku bierzemy udział w wielu międzynarodowych wystawach targowych.
Each year we participate in many international trade show exhibitions.



POSTAL wspiera sport

POSTAL supports sport

WKS „Grunwald” Poznań

sekcja hokeja na trawie
hockey section

Hokeiści WKS „GRUNWALD” Poznań zdobyli:

- 48 medali na Mistrzostwach Polskich w Hokeju na Trawie, w tym 18 tytułów Mistrza kraju,
- 28 medali w Halowych Mistrzostwach Polski, w tym 13 złotych.

The hockey players of WKS "GRUNWALD" Poznan won:

- 48 medals in the Polish Championship in hockey field, including 18 titles of Champion of the country,
- 28 medals in the Polish Indoor Championships, including 13 gold.



Klub Kolarski „TARNOVIA” Tarnowo Podgórne



Kolarze KK „TARNOVIA” Tarnowo Podgórne zdobyli:

- 101 medali, w tym 32 złotych,
- 17 medali, w tym 6 złotych w sezonie 2013.



The cyclists of KK „TARNOVIA” Tarnowo Podgórne won:

- 101 medals, including 32 gold,
- 17 medals, including 6 gold in 2013.



Stalowe elementy kute
do bram, ogrodzeń i balustrad

POSTAL[®]
STEEL GROUP

1.01

elementy spiralne • scrolls • Spiralelemente • спиральные элементы • spirálové elementy

	H	L	N°
A 12x6	80	50	10.091
B 11x5,5	80	50	10.091.03

	H	L	N°
A 12x6	95	60	10.092
B 11x5,5	95	60	10.092.03

	H	L	N°
A 12x6	100	60	10.093
B 11x5,5	100	60	10.093.03

	H	L	N°
A 12x6	115	75	10.094
B 11x5,5	115	75	10.094.03

	H	L	N°
A 12x6	120	70	10.095
B 11x5,5	120	70	10.095.03

	H	L	N°
A 12x6	130	70	10.096
B 11x5,5	130	70	10.096.03

	H	L	N°
A 12x6	150	75	10.097
B 11x5,5	150	75	10.097.03

	H	L	N°
A 12x6	160	80	10.098
B 11x5,5	160	80	10.098.03

	H	L	N°
A 12x6	220	120	10.099
B 11x5,5	220	120	10.099.03

	H	L	N°
A 12x6	150	70	10.100
B 11x5,5	150	70	10.100.03

	H	L	N°
A 12x6	230	115	10.101
B 11x5,5	230	115	10.101.03

	H	L	N°
A 12x6	260	115	10.102
B 11x5,5	260	115	10.102.03

	H	L	N°
A 12x6	170	80	10.103
B 11x5,5	170	80	10.103.03

	H	L	N°
A 12x6	195	90	10.104
B 11x5,5	195	90	10.104.03

	H	L	N°
A 12x6	300	120	10.107
B 11x5,5	300	120	10.107.03

	H	L	N°
A 12x6	330	130	10.108
B 11x5,5	330	125	10.108.03



new

	□	H	L	N°
A	12x6	120	80	10.109
B	11,5x5,5	120	80	10.109.03



new

	□	H	L	N°
A	12x6	250	75	10.125
B	11,5x5,5	250	75	10.125.03

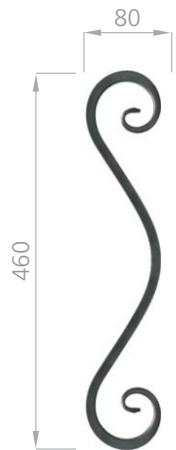

new



□	H	L	N°
12x6	80	50	10.200
12x6	100	60	10.201
12x6	120	70	10.202
12x6	130	75	10.203
12x6	160	80	10.204
12x6	220	130	10.205

□	H	L	N°
12x6	150	65	10.206
12x6	170	80	10.207
12x6	220	100	10.208
12x6	270	110	10.209
12x6	300	120	10.210
12x6	330	130	10.211

	□	H	L	N°
A	12x6	460	80	10.130
B	11,5x5,5	460	80	10.130.03

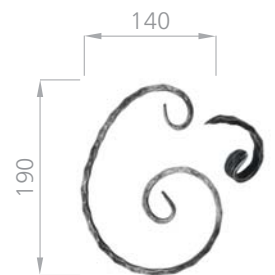
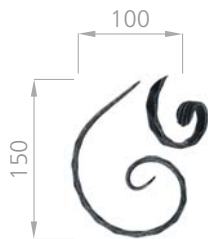

□	HxL (mm)	N°
12x6	160x50	10.213
12x6	150x100	10.214
12x6	120x60	10.215
12x6	120x60	10.216
12x6	190x140	10.217

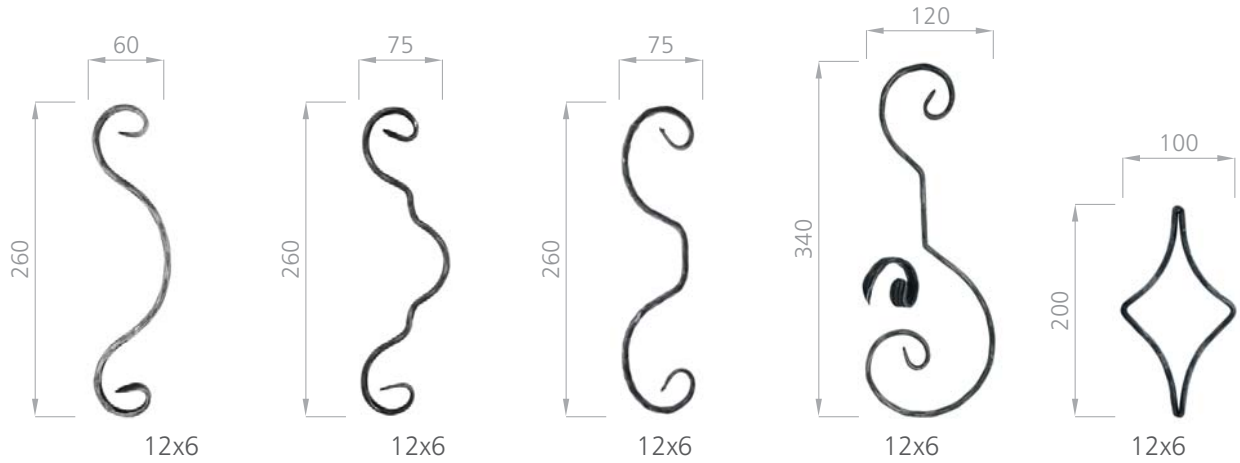

□	12x6	12x6	12x6	12x6	12x6
HxL (mm)	260x60	260x75	260x75	340x120	200x100
N°	10.220	10.221	10.222	10.223	10.224



□	12x6	12x6	12x6	12x6
HxL (mm)	180x120	250x115	180x90	220x120
N°	10.226	10.227	10.230	10.231



□	12x6	12x6	12x6	12x6	12x6	12x6
HxL (mm)	150x100	150x100	190x140	190x140	150x100	150x100
N°	10.240	10.241	10.242	10.243	10.250	10.251

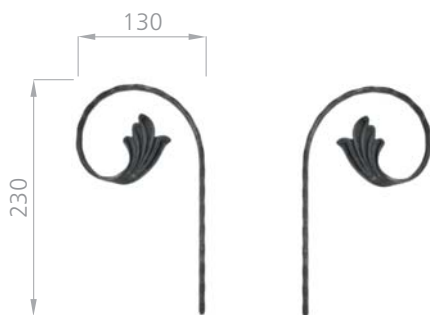

□	12x6	12x6
HxL (mm)	200x130	200x130
N°	10.252	10.253



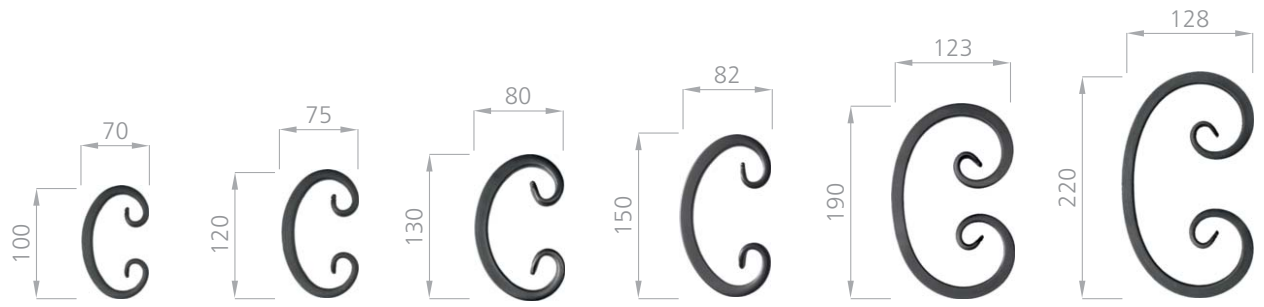

HxL (mm)	100x70	120x75	130x80	150x82	190x123	220x128
----------	--------	--------	--------	--------	---------	---------

□	12x12	12x12	12x12	12x12	12x12	12x12
N°	10.300	10.301	10.302	10.303	10.304	10.305

□	10x10 new	10x10 new	10x10 new	10x10 new	10x10 new	10x10 new
N°	10.400	10.401	10.402	10.403	10.404	10.405

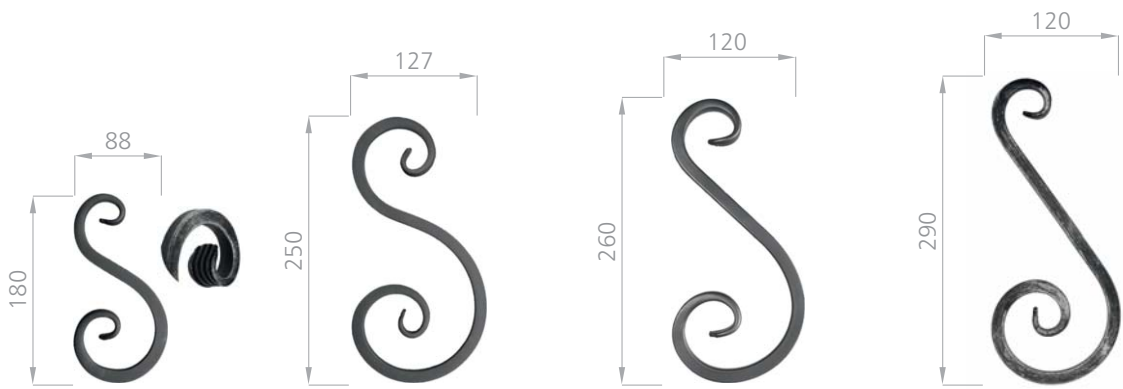

HxL (mm)	180x88	250x127	260x120	290x120
----------	--------	---------	---------	---------

□	12x12	12x12	12x12	12x12
N°	10.310	10.311	10.312	10.313

□	10x10 new	10x10 new	10x10 new	10x10 new
N°	10.410	10.411	10.412	10.413

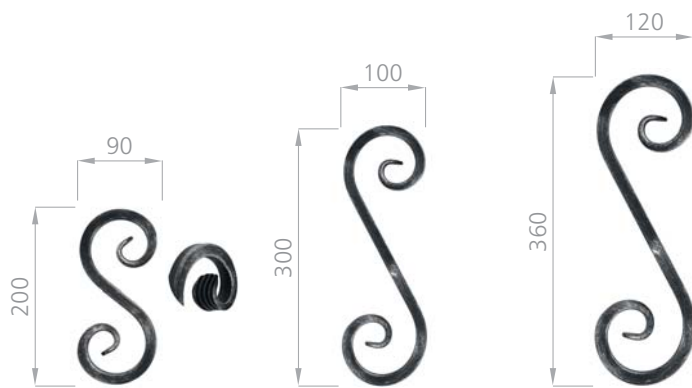

HxL (mm)	200x90	300x100	360x120
----------	--------	---------	---------

□	12x12	12x12	12x12
N°	10.315	10.316	10.317

□	10x10 new	10x10 new	10x10 new
N°	10.415	10.416	10.417

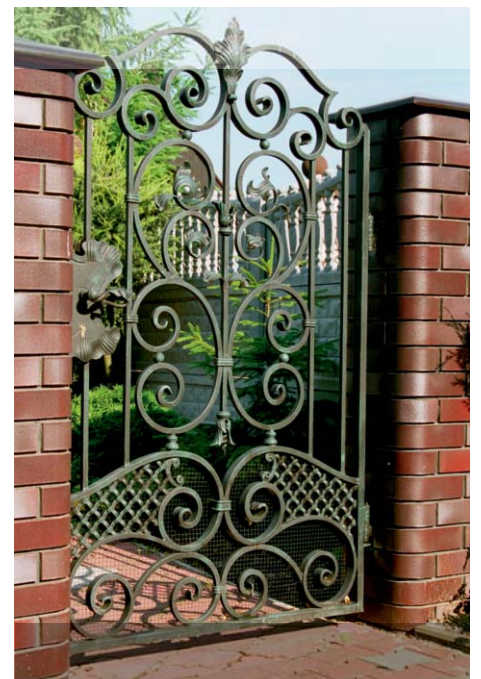

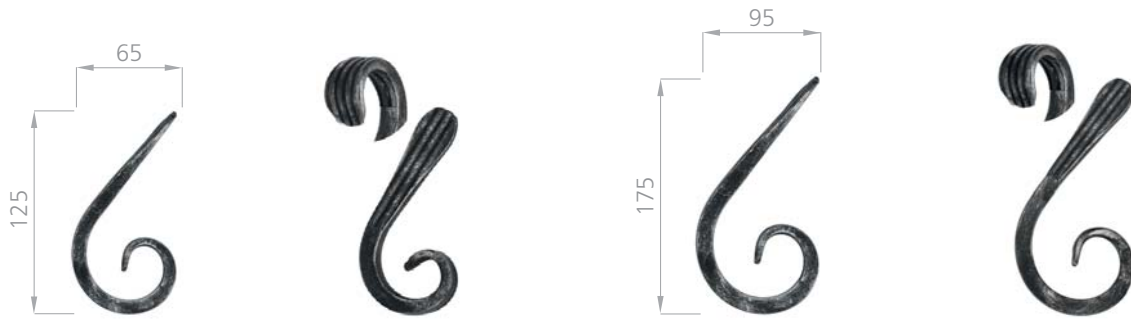

HxL (mm)	125x65	125x65	175x95	175x95
<input type="checkbox"/>	12x12	12x12	12x12	12x12
N°	10.320	10.321	10.322	10.323
<input type="checkbox"/>	10x10 new	10x10 new	10x10 new	10x10 new
N°	10.420	10.421	10.422	10.423

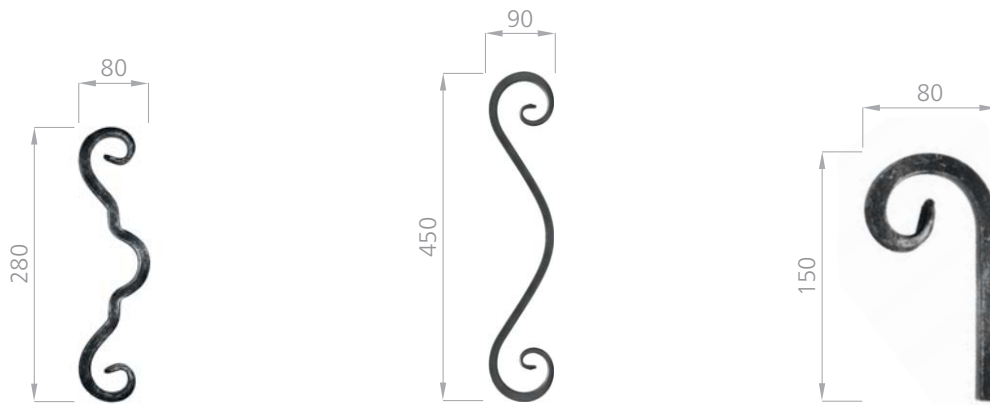

HxL (mm)	280x80	450x90	150x80
<input type="checkbox"/>	12x12	12x12	12x12
N°	10.328	10.330	10.340
<input type="checkbox"/>	10x10 new	10x10 new	10x10 new
N°	10.428	10.430	10.440

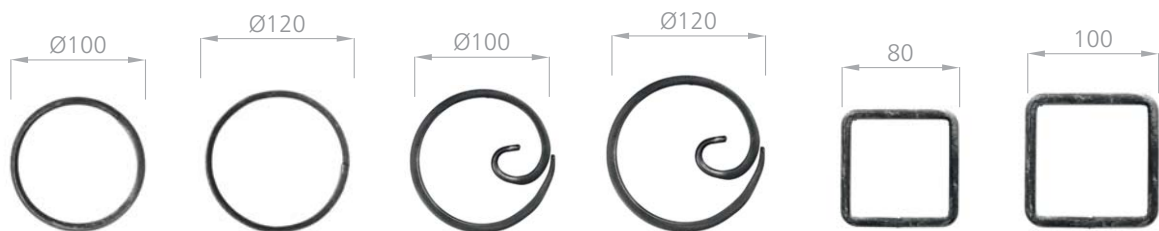







<input type="checkbox"/>	12x6	12x6	12x6	12x6	12x6 new	12x6 new
HxL (mm)	Ø100	Ø120	Ø100	Ø120	80x80	100x100
N°	11.031	11.032	11.041	11.042	11.051	11.052



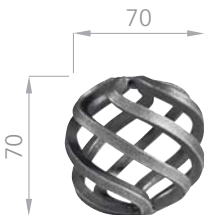









<input type="checkbox"/>	12x6 new	12x6 new	12x6 new	12x6 new	12x6 new
HxL (mm)	190x100	190x120	180x220	180x180	180x180
N°	11.061	11.062	11.091	11.095	11.096

					
HxL (mm)	Ø100	Ø120	Ø100	Ø100	Ø120
	12x6	12x6	12x6	12x12	12x12
Ø (mm)	Ø100	Ø120	Ø100	Ø100	Ø120
N°	11.231	11.232	11.241	11.331	11.332
	10x10	new	10x10	new	new
N°	11.431		11.432		

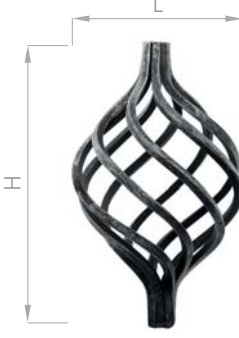
1.02 koszyki • baskets • Körbe • корзины • košíky

					
HxL (mm)	70x70	130x60	130x65	145x65	160x80
N°	12.010	12.080	12.081	12.082	12.083
	6x6	12x12	14x14	16x16	20x20
HxL (mm)	70x70	130x60	130x65	145x65	160x80
N°	12.010	12.080	12.081	12.082	12.083

			
HxL (mm)	130x55	150x70	190x50
N°	12.111	12.112	12.113
	12x12	12x12	12x12
HxL (mm)	130x55	150x70	190x50
N°	12.111	12.112	12.113

				
HxL (mm)	190x120	160x85	210x85	200x50
N°	12.118	12.130	12.131	12.148
	18x18	16x16	16x16	12x12
HxL (mm)	190x120	160x85	210x85	200x50
N°	12.118	12.130	12.131	12.148

1.03 rozety • rosettes • Rosetten • розетки • rozety

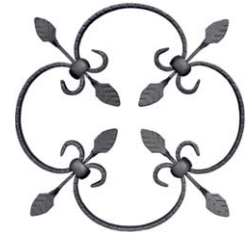
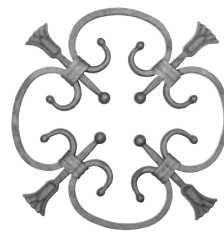

□	12x6	8x8	8x8	20x4
HxL (mm)	240x240	250x250	240x240	250x250
N°	13.000	13.003	13.004	13.005



□	12x12/12x6	12x12/12x6	10x5	12x6
HxL (mm)	375x300	320x250	250x250	300x300
N°	13.006	13.006.01	13.007	13.008

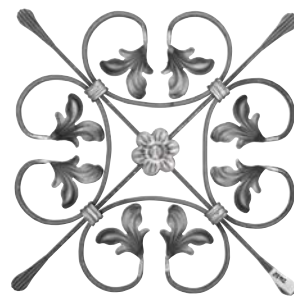
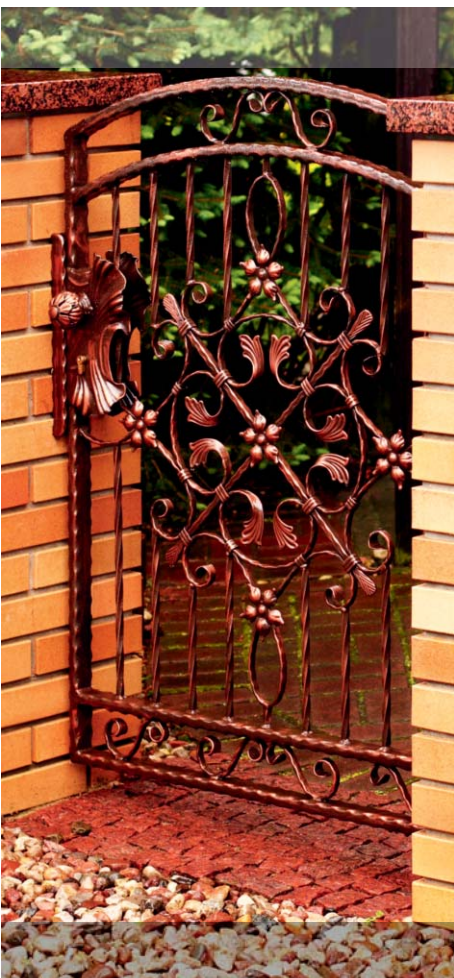

□	12x6
HxL (mm)	340x340
N°	13.009

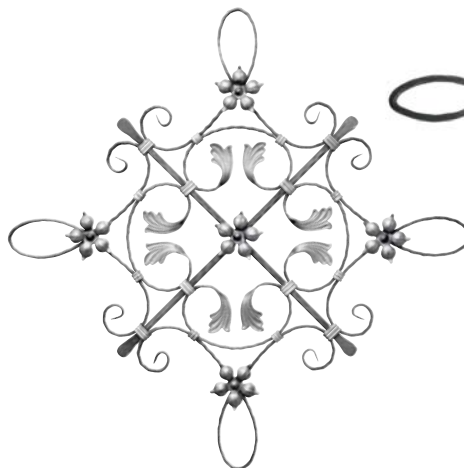

□	12x6	12x12
HxL (mm)	880x880	900x900
N°	13.010	13.011



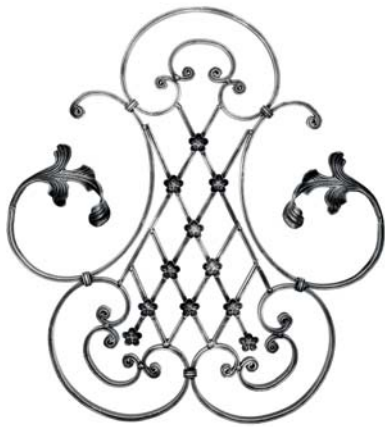

□ 16x8
HxL (mm) 710x640
N° **13.012**

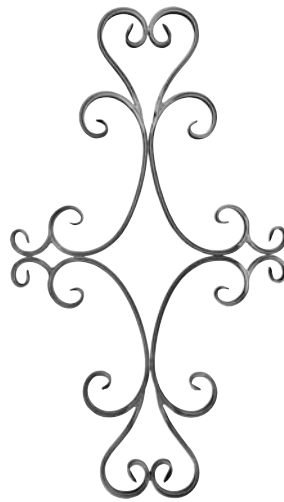

16x8
800x450
N° **13.015**

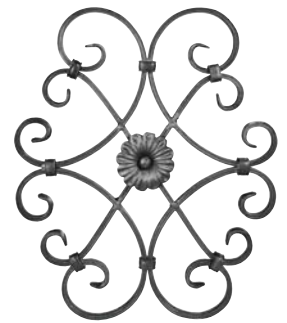

16x8
480x410
N° **13.016**



□ 16x8
HxL (mm) 800x440
N° **13.017**



□ 12x12
HxL (mm) 530x420
N° **13.018**



Ø13
530x420
N° **13.018.01**



10x10
530x420
N° **13.018.02**

new

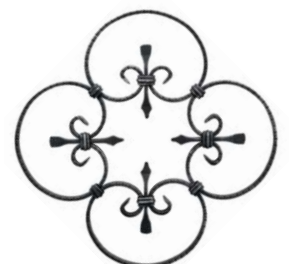

10x5
380x380
N° **13.020**

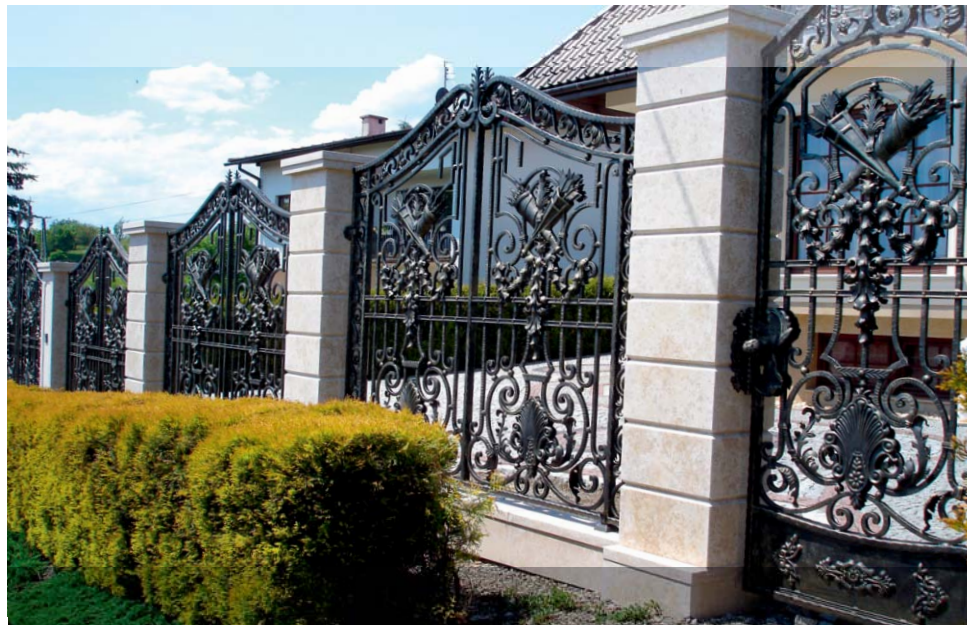



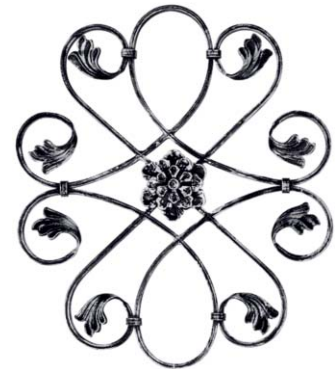
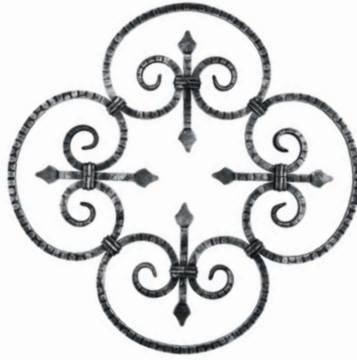

<input type="checkbox"/>	12x12	12x12	16x8
HxL (mm)	630x460	590x590	590x510
N°	13.023	13.025	13.026

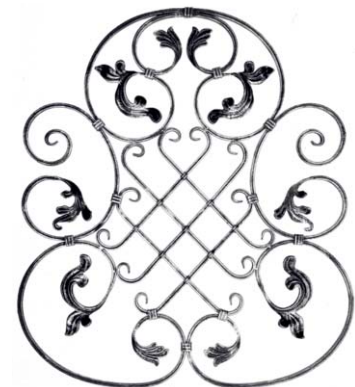
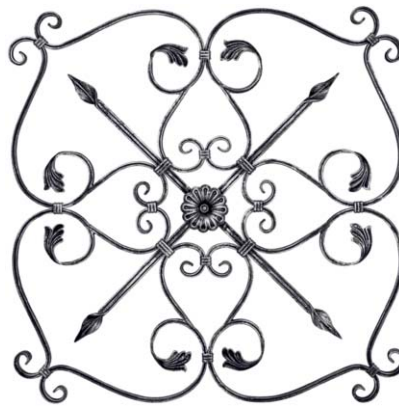

<input type="checkbox"/>	16x8	16x8	16x8
HxL (mm)	670x640	800x800	800x700
N°	13.027	13.028	13.029



<input type="checkbox"/>	12x12	12x12
HxL (mm)	900x385	560x400
N°	13.030	13.032



□	12x12	12x12	12x12	12x12
HxL (mm)	600x370	510x690	480x320	480x250
N°	13.033	13.034	13.035	13.036



□	12x12	12x12	12x12	12x12	12x12
HxL (mm)	450x340	500x250	400x400	400x350	400x300
N°	13.037	13.038	13.039	13.040	13.041



□	16x8	16x8	16x8	16x8	16x8
HxL (mm)	370x880	800x275	800x275	800x300	800x300
N°	13.042	13.043	13.044	13.045	13.046



□	16x8	16x8	16x8
HxL (mm)	530x300	780x780	800x270
N°	13.048	13.056	13.057



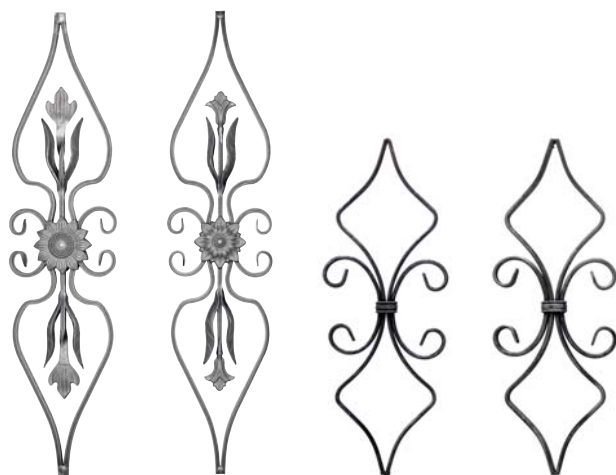

□	16x8	16x8	10x5	12x6
HxL (mm)	800x180	800x180	410x165	410x165
N°	13.058	13.059	13.060	13.061



□	12x6	12x6
HxL (mm)	230x740	230x740
N°	13.067	13.068



□	12x6
HxL (mm)	220x1200
N°	13.070

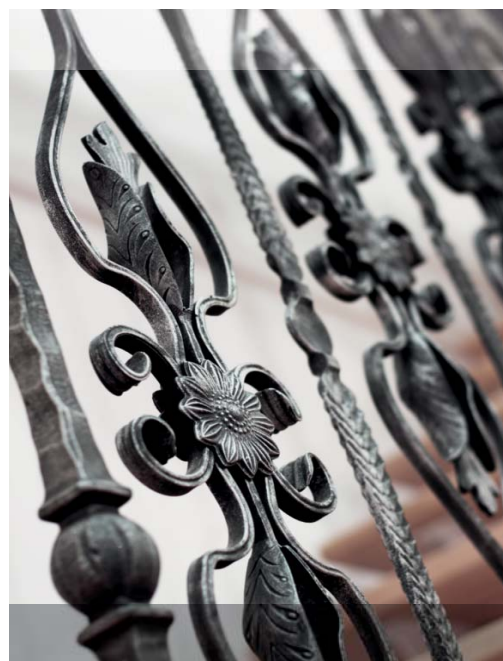

więcej realizacji na:
www.realizacje.postal.pl

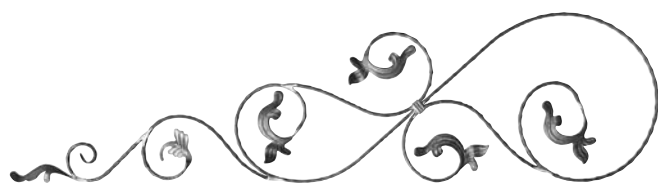

□	16x8
HxL (mm)	380x1500
N°	13.071

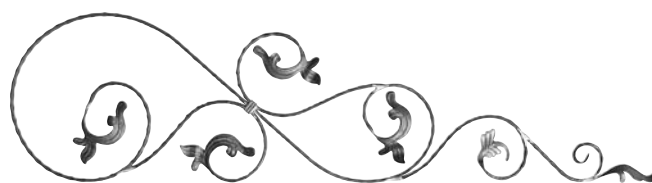

□	16x8
HxL (mm)	380x1500
N°	13.072



□	16x8
HxL (mm)	330x1270
N°	13.073



□	16x8
HxL (mm)	330x1270
N°	13.074

□	16x8
HxL (mm)	170x970
N°	13.090



□	16x8
HxL (mm)	135x950
N°	13.091



□	Ø12
HxL (mm)	170x970
N°	13.092



□	4
HxL (mm)	100x1160
N°	13.093



□	4
HxL (mm)	100x1160
N°	13.094



□	4
HxL (mm)	90x1195
N°	13.096



□	4
HxL (mm)	120x1183
N°	13.097





□	Ø12	Ø12	Ø12	Ø12
HxL (mm)	1050x650	940x500	940x500	1000x800
Nº	13.080	13.081	13.082	13.083

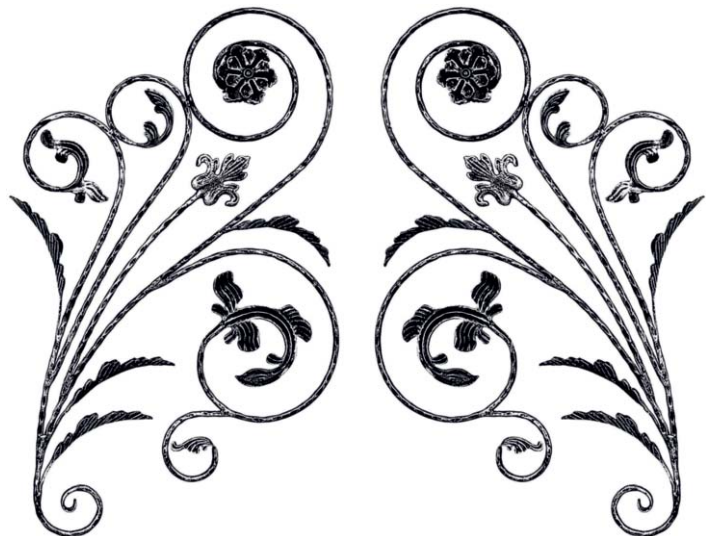

□	Ø12	Ø12
HxL (mm)	1080x600	1080x600
Nº	13.100	13.101



□	Ø12	Ø12	Ø12	Ø12
HxL (mm)	550x750	550x750	880x750	880x750
Nº	13.102	13.103	13.104	13.105



<input type="checkbox"/>	Ø12	Ø12	16x8	16x8
HxL (mm)	880x500	880x500	800x300	800x300
N°	13.106	13.107	13.111	13.112

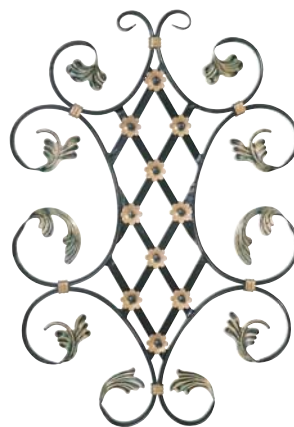

<input type="checkbox"/>	16x8	16x8	16x8	16x8
HxL (mm)	740x320	740x320	750x520	610x700
N°	13.113	13.114	13.125	13.190



<input type="checkbox"/>	16x8	16x8
HxL (mm)	400x800	400x1000
N°	13.191	13.192

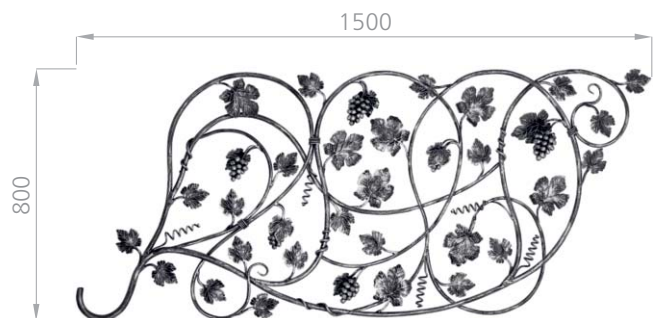

<input type="checkbox"/>	16x8	Ø16, 14, 12
HxL (mm)	600x1580	800x1500
N°	13.198	13.200



□	Ø14	Ø14	Ø14
HxL (mm)	800x165	1000x215	800x165
N°	13.202	13.203	13.204



□	Ø12	Ø12	Ø12	Ø12
HxL (mm)	950x880	950x880	300x190	300x190
N°	13.209	13.210	50.175	50.176

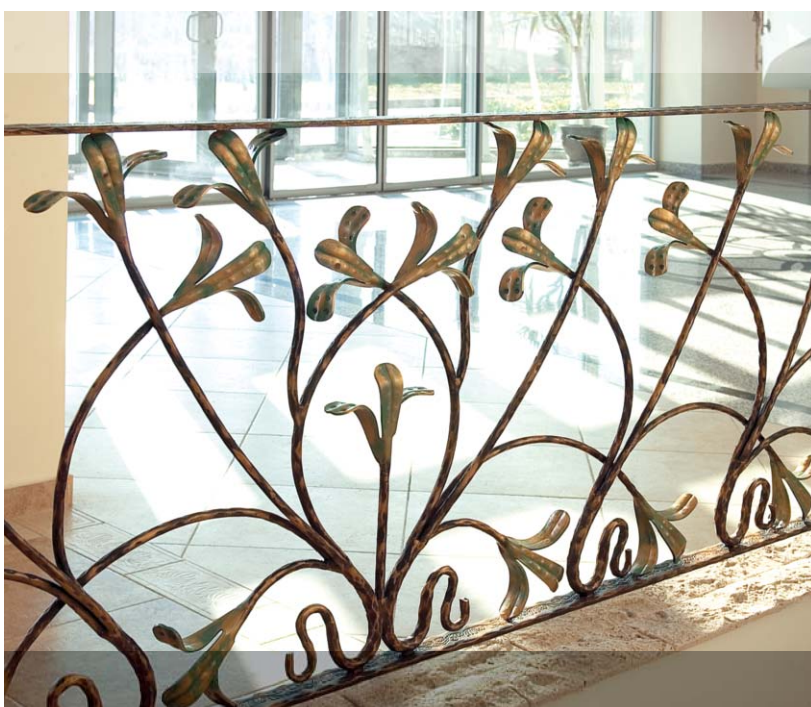



□	12x12	12x12	12x12
HxL (mm)	800x680	385x485	385x540
N°	13.230	13.240	13.241

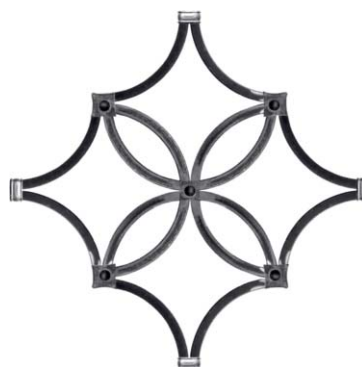

□	12x12	12x12	12x12	12x12
HxL (mm)	385x420	385x440	516x516	Ø385
N°	13.242	13.243	13.244	13.245



□	12x12	12x12	12x12	12x12
HxL (mm)	385x445	Ø250x355	Ø385x440	Ø250x430
N°	13.246	13.247	13.248	13.249



□	12x12
HxL (mm)	Ø385
N°	13.250

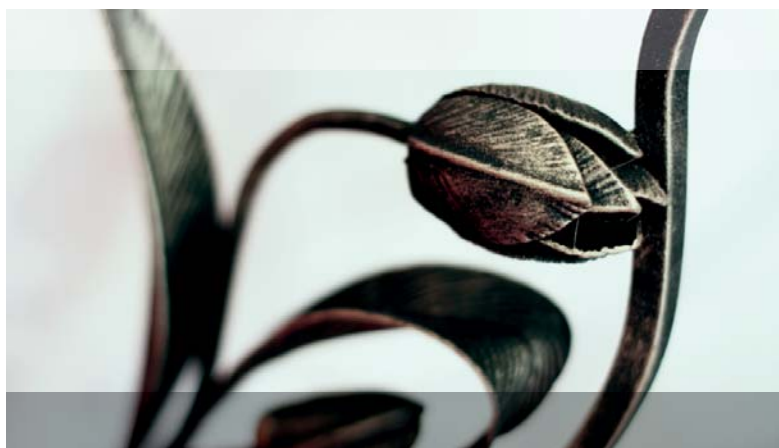



<input type="checkbox"/>	12x12
HxL (mm)	Ø250x525
Nº	13.251



<input type="checkbox"/>	12x12
HxL (mm)	Ø385
Nº	13.252



<input type="checkbox"/>	12x12
HxL (mm)	Ø385x545
Nº	13.253



<input type="checkbox"/>	12x12
HxL (mm)	420x385
Nº	13.254



<input type="checkbox"/>	12x12
HxL (mm)	460x385
Nº	13.255



<input type="checkbox"/>	12x12
HxL (mm)	500x250
Nº	13.256



<input type="checkbox"/>	12x12
HxL (mm)	550x400
Nº	13.301



HxL (mm)	660x470
Nº	13.302



HxL (mm)	530x490
Nº	13.303



HxL (mm)	560x460
Nº	13.304



HxL (mm)	430x340
Nº	13.305



<input type="checkbox"/>	new	new	new	new	new
HxL (mm)	300x205	Ø320	Ø405	300x205	Ø320
	2	2	2	2	2
N°	13.306	13.307	13.308	13.309	13.310



<input type="checkbox"/>	new	new	new	new	new
HxL (mm)	12x12 Ø405	12x12 290x250	12x12 450x384	12x12 310x250	12x12 400x310
	2	2	2	2	2
N°	13.311	13.312	13.313	13.314	13.315



<input type="checkbox"/>	new	new	new	new	new
HxL (mm)	12x12 490x384	12x12 310x250	12x12 400x320	12x12 540x384	12x12 310x250
	2	2	2	2	2
N°	13.316	13.317	13.318	13.319	13.320



<input type="checkbox"/>	new	new	new	new	new
HxL (mm)	12x12 400x320	12x12 490x384	12x12 500x384	12x12 470x384	12x12/12x6 535x384
	2	2			
N°	13.321	13.322	13.323	13.324	13.325







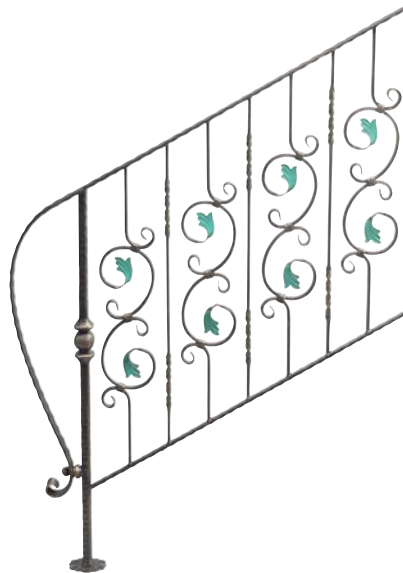
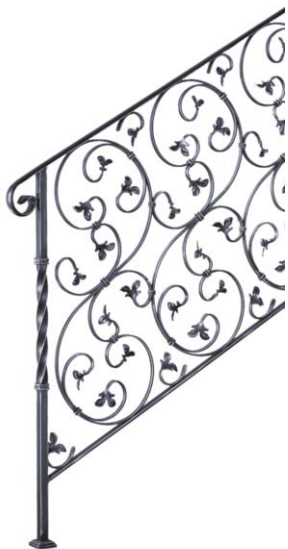
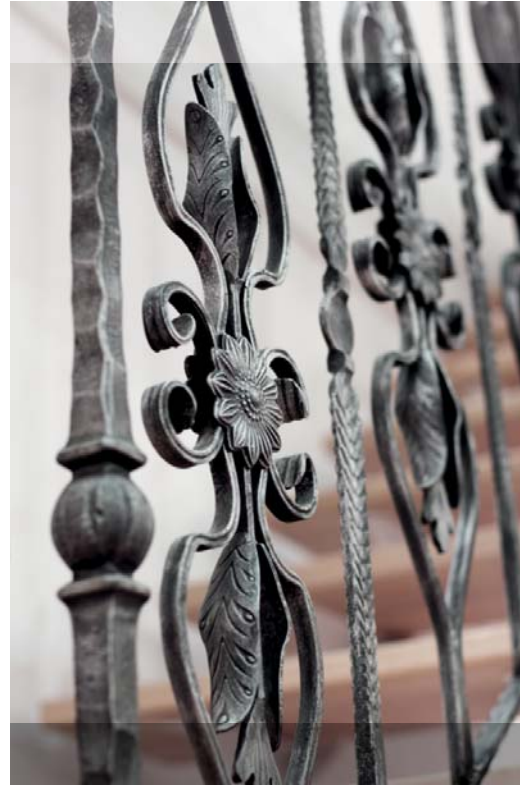

Szukasz ciekawych przykładów stalowych
 bram, ogrodzeń czy balustrad?
 Odwiedź naszą galerię: www.realizacje.postal.pl

















1.04

traki i słupy • balusters and baluster posts • Stäbe und Brüstungspfosten
• балясины • тўčky a sloupky

				
	12x12	12x12	14x14	12x12
HxL (mm)	950x125	950x125	950x125	950x125
N°	20.001	20.001.01	20.002	20.003
				20.003.01

				
	14x14	12x12	12x12	14x14
HxL (mm)	950x125	950x200	950x200	950x200
N°	20.004	20.010	20.010.01	20.011
				20.012

				
	14x14	14x14	12x12	12x12
HxL (mm)	950x200	950x200	950x200	950x200
N°	20.012.01	20.013	20.020	20.030
				20.031



12x12



12x12



12x12



30x5



HxL (mm)

950x200

950x210

800x225

950x170

N°

20.100

20.102

20.105

20.128



30x5



30x5



HxL (mm)

800x170

800x170

N°

20.129

20.130

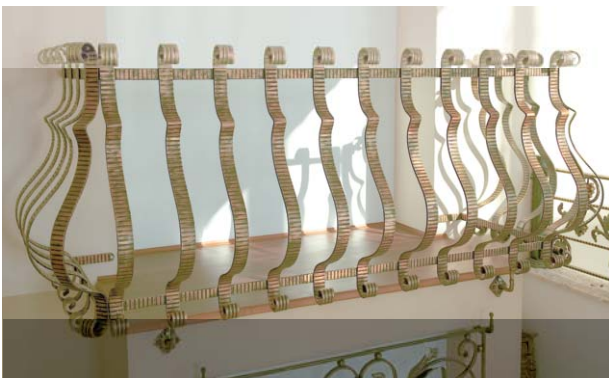

50x10



16x16



HxL (mm)

850x185

950x225

N°

20.148

20.149





□	12x12	12x12	12x12	12x12	12x12	12x12/12x6
HxL (mm)	950	950	950x60	950x60	950x60	950x230
N°	21.010	21.011	21.022	21.024	21.025	21.115



□	12x6
HxL (mm)	860x350
N°	21.116



□	12x12/12x6	16x8	12x12/12x6	12x12/12x6	16x8
HxL (mm)	950x95	950x155	950x270	950x240	950x165
N°	21.117	21.118	21.119	21.120	21.122



□	12x12	16x8
HxL (mm)	950x240	950x120
N°	21.124	21.125

□	12x12	12x12
HxL (mm)	950x200	950x275
N°	21.140	21.141



□	12x12	Ø12	12x12	12x12	12x12
HxL (mm)	950x165	950x180	950x180	950x195	950x200
N°	21.142	21.143	21.144	21.145	21.146



□	12x12	12x12	12x12	12x12	12x12
HxL (mm)	950x200	950x250	950x200	950x210	950x250
N°	21.147	21.148	21.149	21.150	21.151

new

new

new



<input type="checkbox"/>	Ø30x1,5	Ø30x1,5	Ø30x1,5	Ø30x1,5	Ø40x2
H (mm)	900	900	900	900	1200
N°	21.900	21.901	21.902	21.903	24.400



<input type="checkbox"/>	Ø14	Ø14	12x12	12x12	12x12	12x12
HxL (mm)	950xØ36	950xØ36	950x30	950x30	950x35	950x35
N°	22.001	22.002	22.003	22.004	22.005	22.006

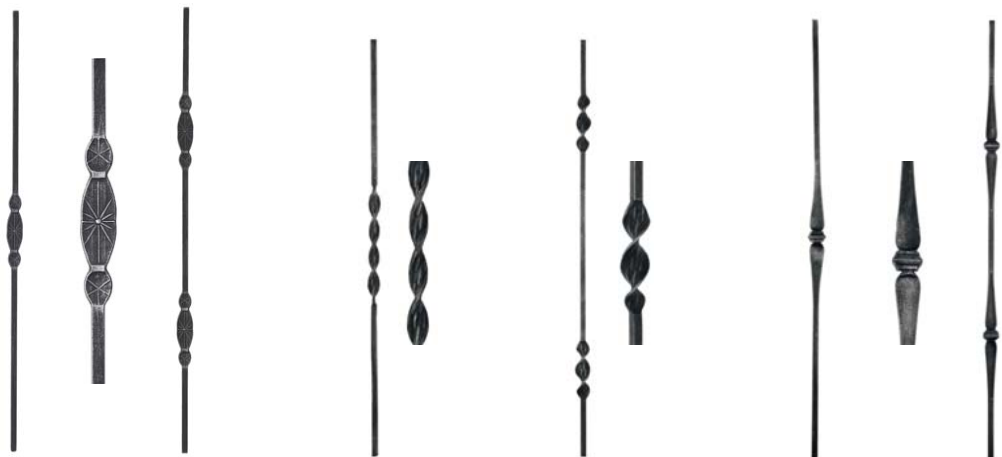

<input type="checkbox"/>	12x12	12x12	12x12	12x12	12x12	12x12
HxL (mm)	950x30	950x30	900x30	900x30	950x36x36	950x36x36
N°	22.007	22.008	22.013	22.014	22.019	22.020

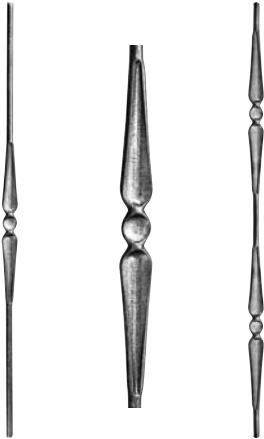

<input type="checkbox"/>	Ø12	Ø12
HxL (mm)	950x30	950x30
N°	22.021	22.022

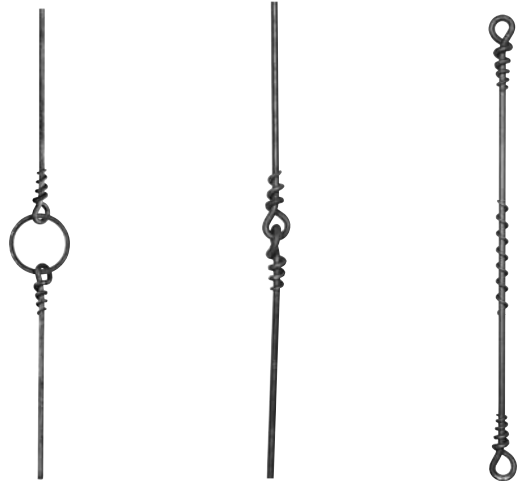
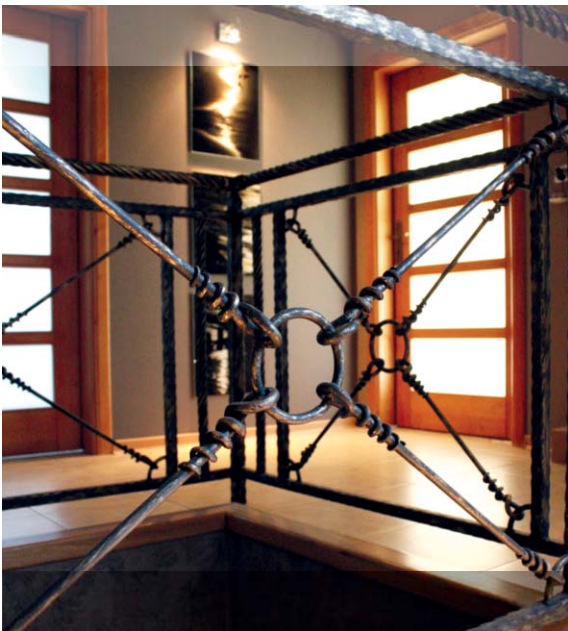
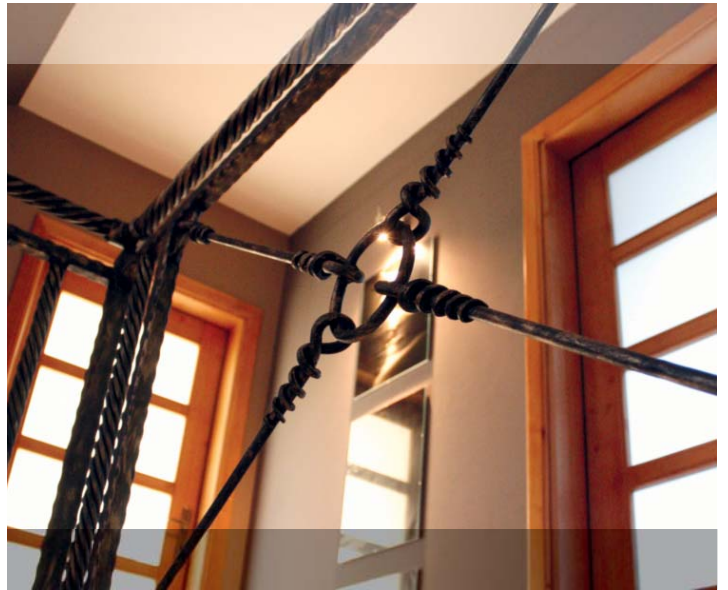

<input type="checkbox"/>	Ø12	Ø12	Ø12
HxL (mm)	1000x120	1000x50	1000x50
N°	22.051	22.052	22.053

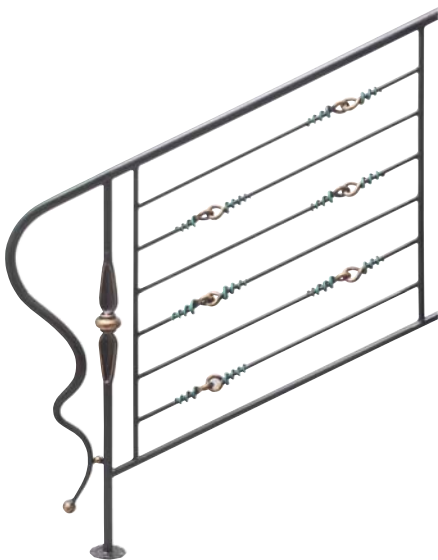



□	12x12	12x12	12x12	12x12
HxL (mm)	950x140	950x185	950x180	950x180
N°	22.100	22.103	22.104	22.105

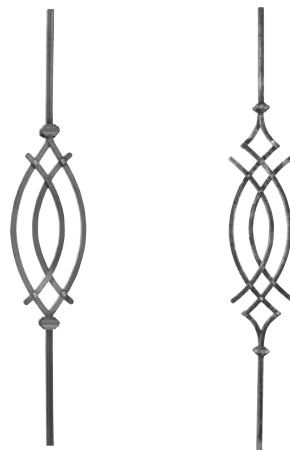

□	12x12	12x12
HxL (mm)	950x180	950x145
N°	22.106	22.107



□	Ø12	Ø12	14x14	14x14	Ø12	Ø12	12x12	12x12
HxL (mm)	950x20	950x20	950x34	950x34	950x24	950x24	950x30	950x30
N°	23.001	23.002	23.003	23.004	23.005	23.006	23.007	23.008

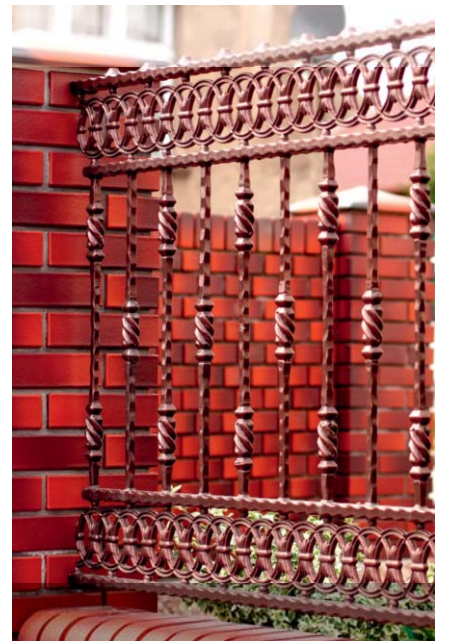
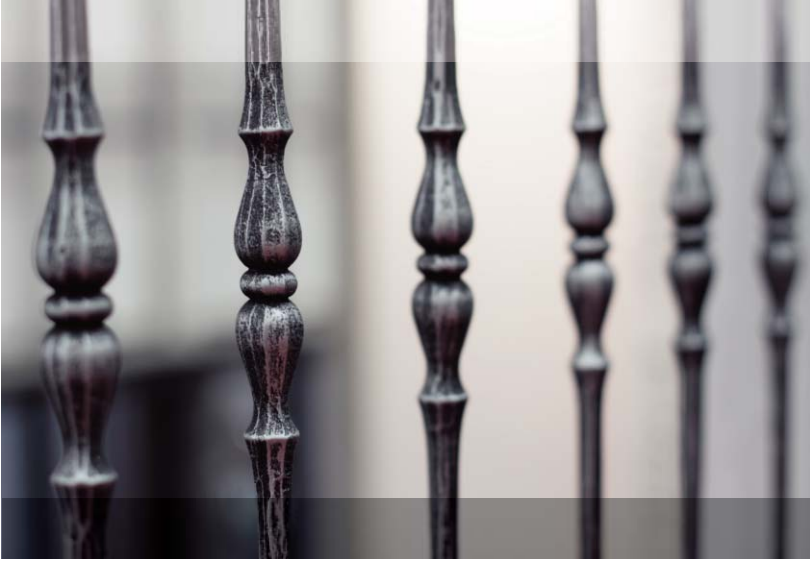

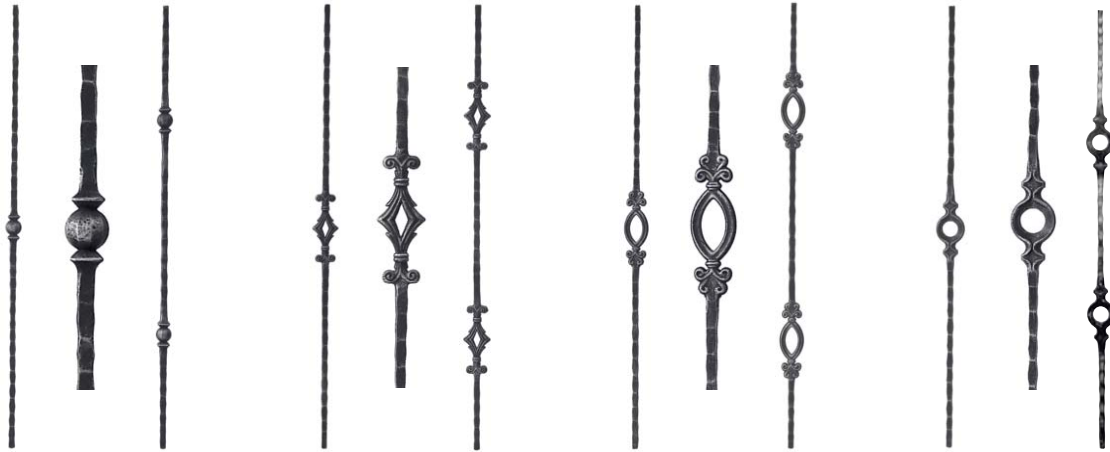

□	14x14	14x14	14x14	14x14	14x14	14x14	14x14	14x14
HxL (mm)	950x34	950x34	950x55	950x55	950x55	950x55	950x65	950x65
N°	23.009	23.010	23.011	23.012	23.013	23.014	23.015	23.016



□	Ø12	Ø12	Ø12	Ø12	Ø12	Ø12	Ø12
HxL (mm)	950x25	950x25	950x20	950x40	950x40	950x27	950x27
N°	23.017	23.018	23.019	23.020	23.021	23.022	23.023



□	14x14	14x14	14x14	20x20	16x16	16x16
HxL (mm)	950x35	950x□40x40	950x□40x40	950x40	950x40	950x60
N°	23.024	23.025	23.026	23.027	23.061	23.065

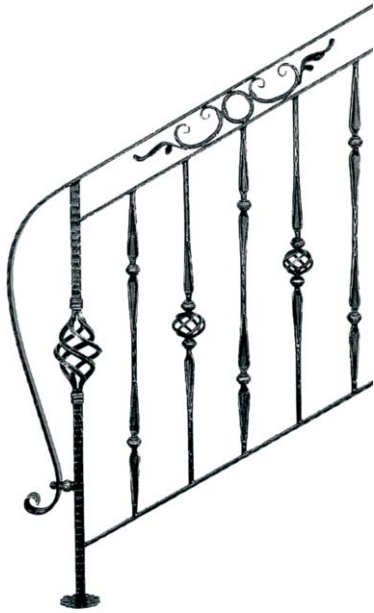

	20x20	20x20	25x25	25x25
HxL (mm)	1200x80	1200x80	1200x60	1200x45
N°	24.010	24.011	24.023	24.101



	25x25	Ø30	Ø25	Ø28
HxL (mm)	1200x50	1200x70	1200x55	1200x60
N°	24.106	24.110	24.111	24.112



	25x25	25x25	25x25	25x25	25x25	25x25	25x25
HxL (mm)	1200x100	1200x50	1200x34	1200x48	1200x50	1200x55	1200x55
N°	24.151	24.254	24.255	24.257	24.259	24.261	24.266



□	Ø35
HxL (mm)	1100x580
N°	24.301



□	30x30	Ø40
HxL (mm)	1100x300	1200
N°	24.303	24.400



1.05 płaskowniki • flat bars • Flachstangen • полосы • ploché tyče



HxL (mm)	3000	6000	100x350	680	180x300	400	300x300	250x200
□	40x10 new	40x10 new	40x10 new	40x10 new	40x10 new	40x10 new	40x10 new	40x10 new
N°	30.003	30.003.00	30.003.01	30.003.02	30.003.03	30.003.04	30.003.05	30.003.06
□	40x12	40x12 new	40x12	40x12	40x12	40x12	40x12	40x12
N°	30.001	30.001.00	30.001.01	30.001.02	30.001.03	30.001.04	30.001.05	30.001.06
□	50x14	50x14 new	50x14	50x14	50x14	50x14	50x14	50x14
N°	30.002	30.002.00	30.002.01	30.002.02	30.002.03	30.002.04	30.002.05	30.002.06



HxL (mm)	3000	100x350	680	180x300	400	300x300	250x200
	40x10	40x10	40x10	40x10	40x10	40x10	40x10
N°	30.004	30.004.01	30.004.02	30.004.03	30.004.04	30.004.05	30.004.06
	50x10	50x10	50x10	50x10	50x10	50x10	50x10
N°	30.005	30.005.01	30.005.02	30.005.03	30.005.04	30.005.05	30.005.06



	Ø32
HxL (mm)	690x155
N°	30.007.01



	40x8	40x8	40x8	40x8	40x8	40x8	40x8
HxL (mm)	3000	100x350	680	180x300	400	300x300	250x200
N°	30.008	30.008.01	30.008.02	30.008.03	30.008.04	30.008.05	30.008.06









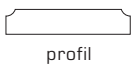

□	40x8	40x8	40x8	40x8	40x8	40x8	40x8
HxL (mm)	3000	100x350	680	180x300	400	300x300	250x200
N°	30.009	30.009.01	30.009.02	30.009.03	30.009.04	30.009.05	30.009.06









HxL (mm)	3000	6000	100x350	680	180x300	400	300x300	250x200
□	40x5 new	40x5 new	40x5 new	40x5 new	40x5 new	40x5 new	40x5 new	40x5 new
N°	30.011	30.011.00	30.011.01	30.011.02	30.011.03	30.011.04	30.011.05	30.011.06
□	40x8	40x8 new	40x8	40x8	40x8	40x8	40x8	40x8
N°	30.010	30.010.00	30.010.01	30.010.02	30.010.03	30.010.04	30.010.05	30.010.06



□	48x20	48x20	48x20	62x30	62x30	62x30
HxL (mm)	3000x1,4	3000x1,4	3000x1,4	3000x1,4	3000x1,4	3000x1,4
N°	30.020	30.020.01	30.020.02	30.021	30.021.01	30.021.02



□	54x54	54x54	54x54	48x20	62x30	54x54
HxL (mm)	3000x1,4	3000x1,4	3000x1,4	40	50	36
N°	30.022	30.022.01	30.022.02	30.030	30.031	30.032

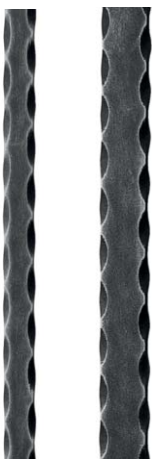

□	L	N°
20x5	3000	30.100
20x5	6000	30.100.00
25x5	3000	30.101
25x5	6000	30.101.00
30x5	3000	30.102
30x5	6000	30.102.00



□	12x6	20x10	16x8
HxL (mm)	3000	3000	3000
N°	30.200	30.202	30.220

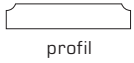

HxL (mm)	3000	6000	100x350	680	180x300	400	300x300	250x200
	40x5 new	40x5 new	40x5 new	40x5 new	40x5 new	40x5 new	40x5 new	40x5 new
N°	30.105	30.105.00	30.105.01	30.105.02	30.105.03	30.105.04	30.105.05	30.105.06
	40x8	40x8 new	40x8	40x8	40x8	40x8	40x8	40x8
N°	30.103	30.103.00	30.103.01	30.103.02	30.103.03	30.103.04	30.103.05	30.103.06

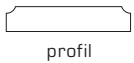

HxL (mm)	3000	6000	100x350	680	180x300	400	300x300	250x200
	40x5	40x5 new	40x5	40x5	40x5	40x5	40x5	40x5
N°	30.111	30.111.00	30.111.01	30.111.02	30.111.03	30.111.04	30.111.05	30.111.06
	40x8	40x8 new	40x8	40x8	40x8	40x8	40x8	40x8
N°	30.121	30.121.00	30.121.01	30.121.02	30.121.03	30.121.04	30.121.05	30.121.06

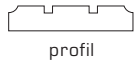

HxL (mm)	3000	6000	100x350	680	180x300	400	300x300	250x200
	40x5	40x5 new	40x5	40x5	40x5	40x5	40x5	40x5
N°	30.113	30.113.00	30.113.01	30.113.02	30.113.03	30.113.04	30.113.05	30.113.06
	40x8	40x8 new	40x8	40x8	40x8	40x8	40x8	40x8
N°	30.123	30.123.00	30.123.01	30.123.02	30.123.03	30.123.04	30.123.05	30.123.06

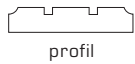

HxL (mm)	3000	6000	100x350	680	180x300	400	300x300	250x200
	40x5	40x5 new	40x5	40x5	40x5	40x5	40x5	40x5
N°	30.114	30.114.00	30.114.01	30.114.02	30.114.03	30.114.04	30.114.05	30.114.06
	40x8 new	40x8 new	40x8 new	40x8 new	40x8 new	40x8 new	40x8 new	40x8 new
N°	30.124	30.124.00	30.124.01	30.124.02	30.124.03	30.124.04	30.124.05	30.124.06

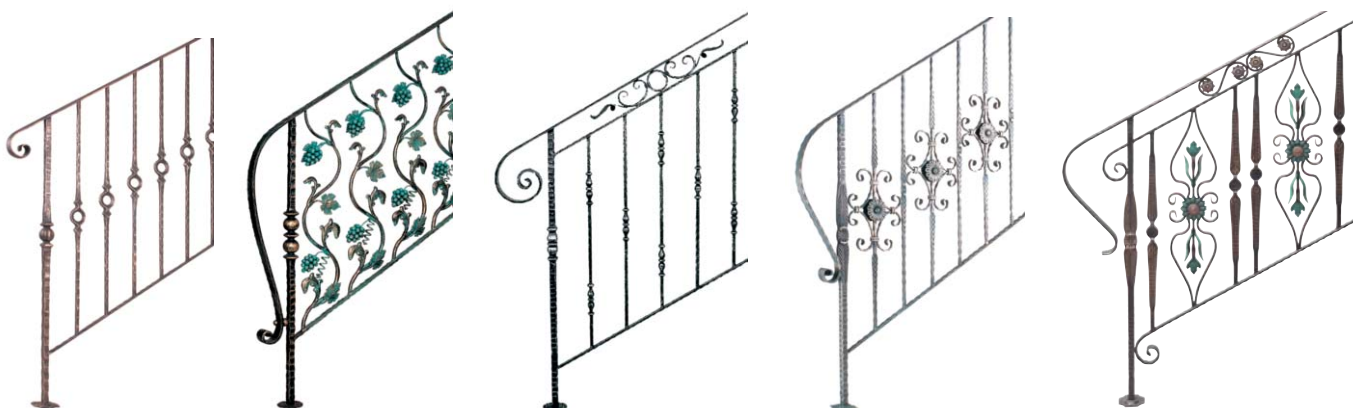

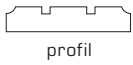

HxL (mm)	3000	6000	100x350	680	180x300	400	300x300	250x200
	40x5	40x5 new	40x5	40x5	40x5	40x5	40x5	40x5
N°	30.115	30.115.00	30.115.01	30.115.02	30.115.03	30.115.04	30.115.05	30.115.06
	40x8	40x8 new	40x8	40x8	40x8	40x8	40x8	40x8
N°	30.125	30.125.00	30.125.01	30.125.02	30.125.03	30.125.04	30.125.05	30.125.06

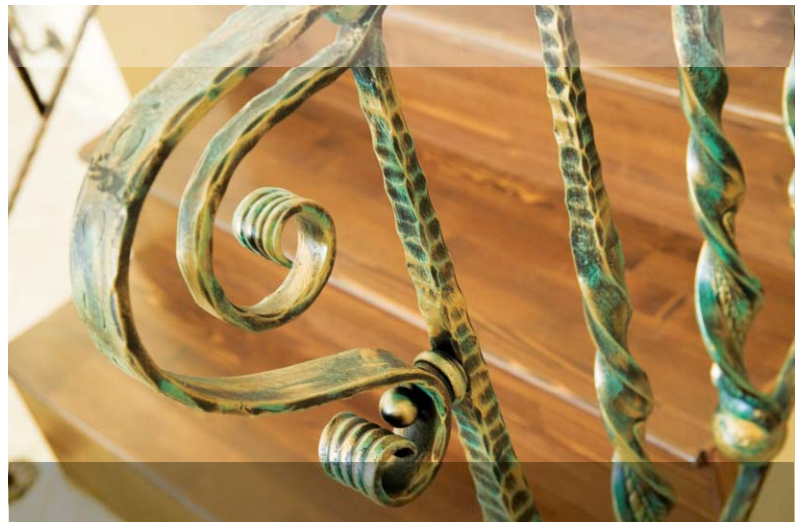
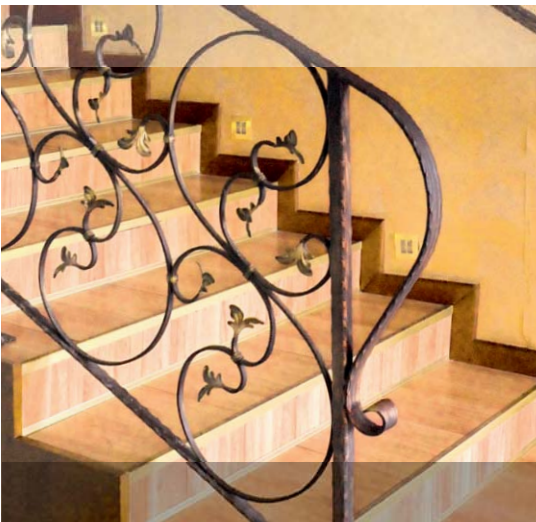

1.06 taśmy • banding materials • Bände • ленты • pásoviný

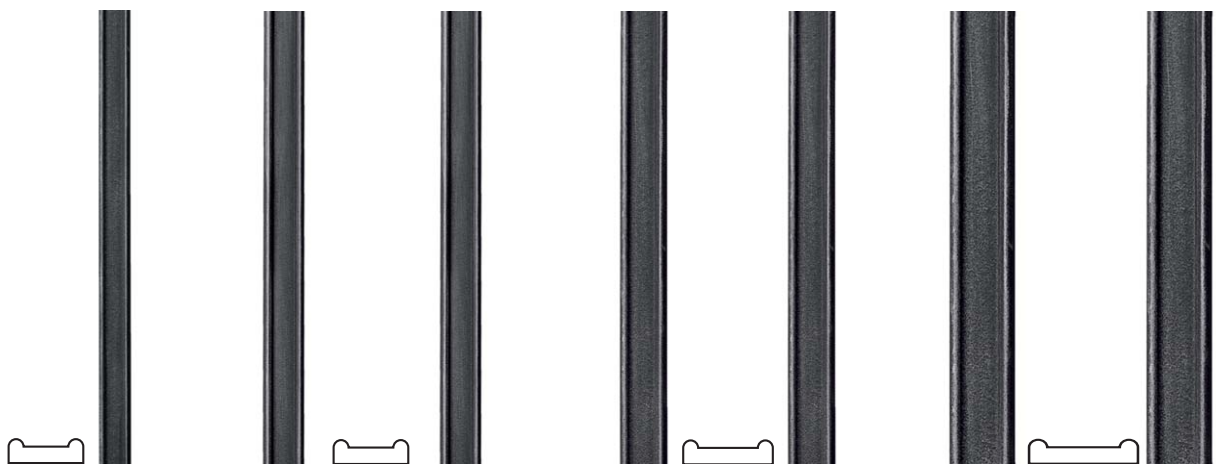

	14x4	25x8	25x8	30x8	30x8	40x8	40x8
HxL (mm)	4000	3000	6000	3000	6000	3000	6000
N°	31.100	31.101	31.101.00	31.102	31.102.00	31.103	31.103.00

miękkie • soft and flexible

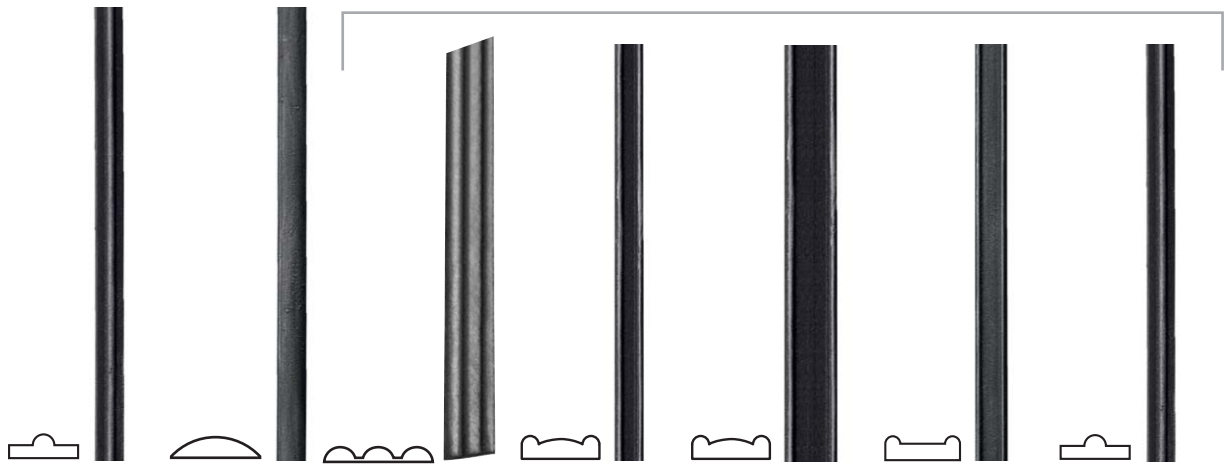

□	14x4	14x4	18x1,5	14x3	20x4	14x4	14x4
HxL (mm)	4000	4000	2000	3000	3000	3000	3000
N°	31.200	31.300	31.350	31.400	31.402	31.403	31.404



□	H	N°
12x12	3000	32.001
12x12	6000	32.001.00
14x14	3000	32.003
14x14	6000	32.003.00
16x16	3000	32.005
16x16	6000	32.005.00
20x20	3000	32.007



□	H	N°
Ø8	3000	32.111
Ø10	3000	32.112
Ø10	6000	32.112.00
Ø12	3000	32.113
Ø12	6000	32.113.00
Ø14	3000	32.114
Ø14	6000	32.114.00
Ø16	3000	32.115
Ø16	6000	32.115.00
Ø20	3000	32.117
Ø24	3000	32.119



□	H	N°
Ø10-12	1100	32.100
Ø12-16	1100	32.101
Ø16-20	1100	32.102



□	H	N°
Ø25	2750	32.200
Ø30	2750	32.201
Ø38	2750	32.202
Ø48	2750	32.203

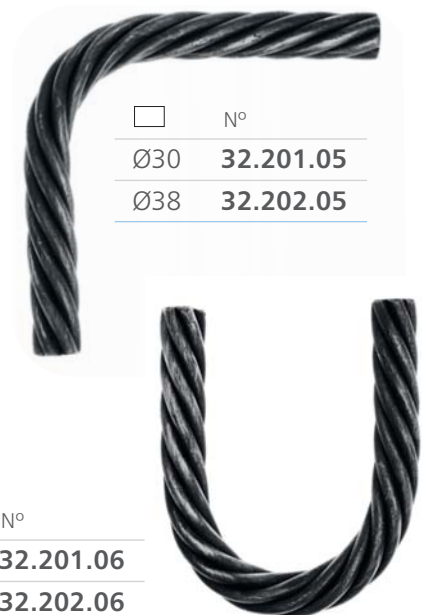

□	N°
Ø30	32.201.06
Ø38	32.202.06

1.07

pręty ozdobne • decorative bars • dekorative Stäbe • декоративные прутья • tyče ozdobné



12x12

2000

33.000



14x14

2000

33.001



14x14

2000

33.013



Ø14

2000

33.023



HxL (mm)

N°



125



125



135

□ H N°

12x12 2000 33.098

14x14 2000 33.100

□ H N°

12x12 2000 33.099

14x14 2000 33.101

□ H N°

16x16 2000 33.102

20x20 2000 33.104



□ H N°

12x6 2000x65 33.201

12x12 2000x65 33.203

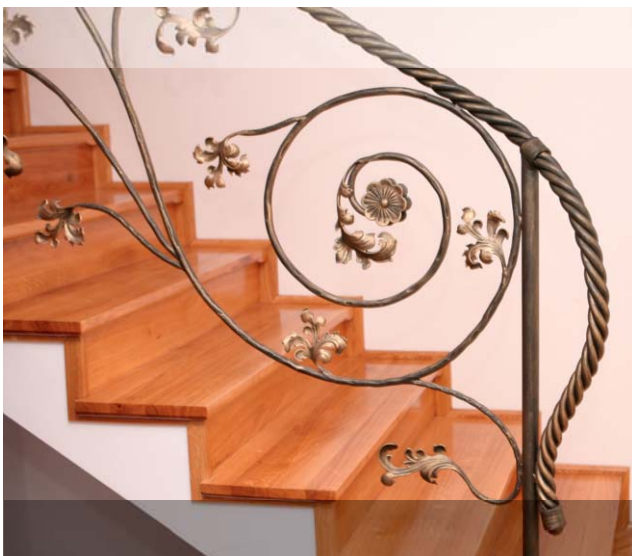

1.08

profile zamknięte • bars • verikant Rohre • прутья • tyče průvlakové



	20x20x2	20x20x2	25x25x2	25x25x2	30x30x2	30x30x2	40x40x2,5	40x40x2,5
HxL (mm)	3000	6000	3000	6000	3000	6000	3000	6000
N°	34.002	34.002.00	34.005	34.005.00	34.008	34.008.00	34.011	34.011.00

	50x50x3	50x50x3	60x60x3	60x60x3	80x80x3	80x80x3	100x100x3	100x100x3
HxL (mm)	3000	6000	3000	6000	3000	6000	3000	6000
N°	34.014	34.014.00	34.017	34.017.00	34.020	34.020.00	34.023	34.023.00











	30x20x2	30x20x2	40x20x2	40x20x2	40x30x2	40x30x2	50x30x3	50x30x3	60x40x3	60x40x3
HxL (mm)	3000	6000	3000	6000	3000	6000	3000	6000	3000	6000
N°	34.102	34.102.00	34.105	34.105.00	34.107	34.107.00	34.111	34.111.00	34.120	34.120.00











	Ø20x1	Ø30x1,2	Ø40x1,2	Ø50x1,5	Ø20x1	Ø30x1,2	Ø40x1,2	Ø50x1,5
H (mm)	3000	3000	3000	3000	3000	3000	3000	3000
N°	34.220	34.221	34.230	34.231	34.240	34.241	34.250	34.251

1.09

groty • spears • Spitzen • пики • hroty

								
□	Ø15	Ø16	Ø24	Ø25	Ø30	Ø18	Ø12	Ø15
HxL (mm)	150x55	150x66	160x63	110x55	125x65	110x48	100x45	125x55
N°	40.001	40.002	40.003	40.006	40.007	40.008	40.011	40.012

										
□	Ø16	Ø15	Ø20	Ø24	Ø25	Ø21	Ø13	Ø13	Ø20	Ø26
HxL (mm)	145x120	74x55	99x72	128x65	140x70	137x38	125x60	130x53	110x60	135x70
N°	40.013	40.015	40.016	40.017	40.018	40.020	40.041	40.045	40.048	40.049

								
□	Ø20	Ø30	Ø12	Ø12	Ø17	Ø20	Ø25	Ø38
HxL (mm)	130x70	160x90	130x60	130x60	155x70	80x45	125x65	140x80
N°	40.050	40.051	40.052	40.052.02	40.053	40.055	40.056	40.057





□	Ø20	Ø25	Ø20	Ø16	Ø20	Ø26	12x12	14x14
HxL (mm)	120x55	135x65	115x58	82x40	115x58	140x70	120x42	140x47
N°	40.058	40.059	40.060	40.060.01	40.060.02	40.061	40.065	40.066



□	12x12	14x14	Ø25	Ø20	Ø25	Ø20	Ø30	Ø32	Ø25
HxL (mm)	150x40	180x43	125x40	95x30	135x40	98x33	160x50	190x55	135x40
N°	40.067	40.068	40.071	40.071.01	40.072	40.072.01	40.073	40.074	40.075



□	Ø32	Ø25	15x15	18x14	20x16	Ø16	Ø16	Ø25
HxL (mm)	125x60	110x50	140x50	100x55	130x75	155x65	160x65	125x45
N°	40.077	40.077.02	40.078	40.079	40.079.01	40.080	40.081	40.083









□	Ø33	Ø40	20x20	25x25	40x40	20x20	15x15
HxL (mm)	140x57	190x68	100x20	160x25	150x40	125x30	82x20
N°	40.084	40.085	40.088.01	40.089	40.090	40.092	40.092.01

















□	32x32	40x40	12x12	Ø18	24x24	Ø24	Ø30	Ø33
HxL (mm)	160x40	190x50	95x27	125x40	60x35	88x28	120x35	150x40
N°	40.093	40.094	40.095	40.096	40.097	40.098.03	40.098.02	40.098.01





							
□	Ø19	25x25	30x30	40x40	18x21	Ø16	Ø21
HxL (mm)	190x75	120x67	155x92	200x117	105x53	160x90	165x70
N°	40.099	40.099.01	40.099.02	40.099.03	40.099.04	40.100	40.101

							
□	Ø13	14x14	Ø15	Ø16	Ø25	15x15	15x15
HxL (mm)	140x50	110x50	180x60	160x65	160x70	145x80	140x80
N°	40.102	40.102.01	40.103	40.104	40.105	40.106	40.107

							
□	Ø50	18x18	26x26	Ø40	Ø16	Ø29	Ø35
HxL (mm)	170x85	245x80	290x75	200x100	120x73	180x60	205x65
N°	40.109	40.110	40.111	40.112	40.112.01	40.117	40.118





□	12x12	20x20	Ø33	12x12	12x12	14x14	16x16	23x23
HxL (mm)	90x63	135x90	130x47	170x30	150x30	150x30	57x38	115x96
N°	40.123	40.125	40.126	40.132	40.133	40.138	40.140	40.142



□	Ø12	12x12	16x16	16x16	20x20	Ø16	Ø26	Ø24
HxL (mm)	92x35	120x35	107x25	142x28	148x35	132x85	134x64	155x68
N°	40.150	40.151	40.153	40.154	40.155	40.156	40.157	40.158



□	Ø35	16x16	26x26	12x12	14x14	12x12	14x14
HxL (mm)	145x36	105x60	140x88	200	200	200	200
N°	40.159	40.162	40.163	40.170	40.171	40.174	40.175



□	Ø22	Ø27	14x18	15x15	18x18	23x23	
HxL (mm)	80x22	110x27	97x55	82x15	110x18	140x23	150x85
N°	40.200	40.201	40.204	40.210	40.211	40.212	40.300

1.10 przekuwki • slugs • Rohraufsätze • насадки • návleky

	12,5		12,5		14,5	14,5	Ø14,5	Ø14,5
HxL (mm)	39x40	39x40	67x40	67x40	44x45	67x45	39x40	67x40
N°	41.001	41.001.01	41.002	41.002.01	41.003	41.004	41.005	41.006



	16,5	16,5	Ø16,5	Ø16,5	12,5	12,5
HxL (mm)	44x45	67x45	44x45	67x45	40x38	65x38
N°	41.007	41.008	41.011	41.012	41.021	41.022

	14,5	14,5	16,5	16,5	Ø35,5	30,5	27
HxL (mm)	40x38	65x38	40x38	65x38	80x69	80x69	215x63
N°	41.023	41.024	41.025	41.026	41.050	41.060	41.070

	12,5	14,5	16,5	21x21 new	Ø12,5	Ø14,5	Ø16,5
HxL (mm)	22x40	22x40	22x40	25x45	25x35	22x40	22x40
N°	41.102	41.104	41.105	41.106	41.111	41.114	41.115

	12,5	14,5	16,5	20,5	25,5	14,5 new	14,5	14,5
HxL (mm)	22x33	22x38	22x38	35x55	35x55	55x48	70x35	130x35
N°	41.202	41.204	41.205	41.206	41.207	41.210	41.306	41.307

								
□	Ø14,5	Ø14,5	16x16	16x16	Ø16	Ø16	Ø12	12x12
HxL (mm)	70x35	130x35	75x42	148x48	75x38	128x40	140x28	140x26
N°	41.311	41.312	41.315	41.316	41.317	41.318	41.400	41.401

							
□	12x12	14x14	12-14	16-20	20x20	Ø14	Ø14
HxL (mm)	160x25	80x32	75x30	75x35	140x35	95x40	120x40
N°	41.402	41.403	41.407	41.408	41.409	41.450	41.451



new

□	H	L	N°
12,5x12,5	126	40	41.460
14,5x14,5	126	40	41.461
16,5x16,5	126	40	41.462











new

□	H	L	N°
12,5x12,5	126	40	41.463
14,5x14,5	126	40	41.464
16,5x16,5	126	40	41.465

1.11

gałki • knobs • Knöpfe • набалдашники • šišky

								
□	Ø28	Ø40	Ø100	Ø50	25x25	40x40	Ø27	Ø42
HxL (mm)	80	90	180	90	60	85	60	85
N°	42.000	42.001	42.002	42.003	42.004	42.005	42.006	42.007

							
HxL (mm)	45	60	70	80	95	160	120
N°	42.011	42.012	42.013	42.014	42.020	42.021	42.022



HxL (mm) 220x200
N° 42.030



Ø51x75x1,5
N° 42.100



Ø58x93x1,5
N° 42.101





















Ø77x102x1,5
N° 42.102



1.12

kule • spheres • Kugeln • шары • koule

							
N°	43.015	43.020	43.025	43.030	43.035	43.040	43.050

										
N°	43.120	43.125	43.130	43.135	43.140	43.150	43.220	43.230	43.240	43.250



	Ø40	Ø50	Ø60	Ø70	Ø80	Ø100	Ø120	Ø150
N°	43.504	43.505	43.506	43.507	43.508	43.510	43.512	43.515



	Ø15	Ø20	Ø25	Ø30	Ø35
N°	43.615	43.620	43.625	43.630	43.635

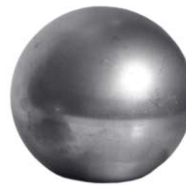
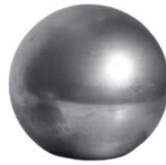
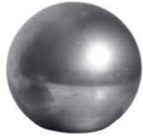
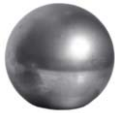

	Ø40	Ø50	Ø60	Ø70	Ø80
N°	43.640	43.650	43.660	43.670	43.680



Ø40

Ø50

Ø60

Ø70

Ø80

N°	43.640.01	43.650.01	43.660.01	43.670.01	43.680.01
----	------------------	------------------	------------------	------------------	------------------

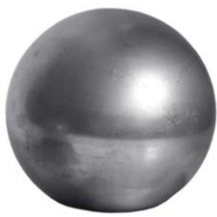

	Ø90	Ø100	Ø120	Ø150
N°	43.690	43.700	43.720	43.750



Ø90

Ø100

Ø120

Ø150

Ø200

N°	43.690.01	43.700.01	43.720.01	43.750.01	43.800.01
----	------------------	------------------	------------------	------------------	------------------

1.13

maskownice • masking frames • Blenden • маскировочные элементы • zákrytky

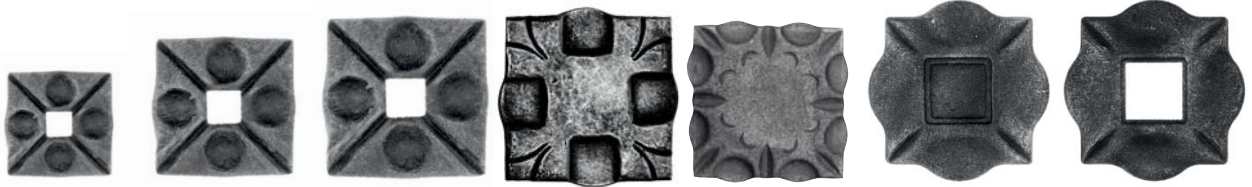

	12x12	21x21	26x26	new			30x30
HxL (mm)	50x50	70x70	90x90	100x100	90x90	100x100	100x100
	6	8	8	8	5	10	10
N°	44.001	44.004	44.006	44.008	44.010	44.011	44.013



			13x13		26x26		
HxL (mm)	60x60	65x65	65x65	100x100	100x100	Ø65	Ø90
	5	4	4	4	4	4	4
N°	44.014	44.017	44.018	44.020	44.022	44.026	44.029



	21x21 new	26x26 new			21x21 new	26x26
HxL (mm)	Ø90	Ø90	Ø110	Ø110	Ø110	Ø110
	4	4	4	4	4	4
N°	44.030	44.031	44.034	44.035	44.036	44.036



					21x21 new	26x26 new
HxL (mm)	85x85	120x120	60x60	80x80	80x80	80x80
	8	8	4	4	4	4
N°	44.038	44.039	44.040	44.043	44.044	44.045



	12,5x12,5	14,5x14,5	16,5x16,5	20,5x20,5	25,5x25,5	30,5x30,5	40,5x40,5
HxL (mm)	15x50x50	15x50x50	15x50x50	17x80x80	17x80x80	17x80x80	17x80x80
	4	4	4	4	4	4	4
N°	44.046	44.047	44.048	44.049	44.050	44.051	44.052



□	40,5x20,5	40,5x30,5	14,5x14,5		12x12
HxL (mm)	17x80x80	17x80x80	Ø90	62x62	62x62
	4	4	4	2	2
N°	44.053	44.054	44.060	44.066	44.067



□		12x12		12x12	16x16	24x24
HxL (mm)	75x75	75x75	Ø75	Ø75	Ø75	Ø75
	2	2	2,5	2,5	2,5	2,5
N°	44.070	44.071	44.074	44.075	44.076	44.077



□	30,5x30,5	40,5x40,5	25,5x25,5	30,5x30,5	20,5x20,5
HxL (mm)	25x80x80	25x80x80	20x60x60	20x60x60	20x50x50
N°	44.119	44.121	44.122	44.123	44.126



□	12,5x12,5	14,5x14,5	16,5x16,5			
HxL (mm)	15x40x40	15x40x40	15x40x40	Ø60x20	Ø40x20	Ø30x20
N°	44.127	44.128	44.129	44.134	44.136	44.137



□	Ø12,5 <i>new</i>	Ø14,5 <i>new</i>	Ø16,5 <i>new</i>	Ø25	Ø32	Ø38	Ø42	Ø48	Ø51
HxL (mm)	20xØ50	20xØ50	20xØ50	25xØ80	25xØ80	30xØ97	30xØ97	30xØ97	30xØ110
	1	1	1	1	1	1	1	1	1
N°	44.138	44.139	44.139.01	44.140	44.141	44.142	44.143	44.144	44.145

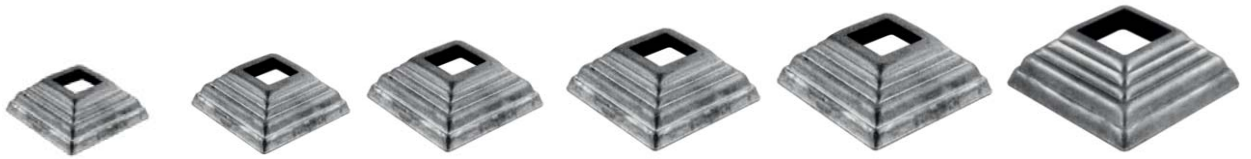

□	12x12	14x14	16x16	20x20	25x25	30x30	40x40
HxL (mm)	19x44x44	19x44x44	19x44x44	22x57x57	30x80x80	30x80x80	30x90x90
	1	1	1	1	1	1	1
N°	44.146	44.147	44.148	44.149	44.150	44.151	44.152



□	50x50	60x60	80x80	100x100	40x30	40x60	40x20 new
HxL (mm)	30x100x100	28x109x109	28x120x120	28x142x142	30x85x75	28x90x110	30x100x100
	1	1	1	1	1	1	1
N°	44.153	44.154	44.155	44.156	44.157	44.158	44.159



HxL (mm)	155x70	120x50	145x60	200x85	280x120	160x105
	4	4	4	4	5	6
N°	44.200	44.201	44.202	44.203	44.204	44.205



HxL (mm)	160x102 new	195x88 new	135x38
	3	3	
N°	44.206	44.207	44.220



1.14

kwiaty i liście • flowers and leaves • Blumen und Blätter • цветы и листья • květy a listy



<input type="checkbox"/>						Ø10	Ø10
HxL (mm)	Ø40 new	Ø95	Ø68 new	Ø95	Ø62	Ø60	Ø90
	1,2	5	1,2	5	4	3	3
N°	50.000	50.001	50.002	50.003	50.004	50.005	50.006



<input type="checkbox"/>	Ø12	Ø12		Ø12	Ø12	Ø12	
HxL (mm)	Ø98	Ø115	Ø60	Ø68	Ø97	Ø120	Ø95
	3	3	2	1,5	1,5	2	2
N°	50.007	50.008	50.009	50.010	50.011	50.012	50.013



<input type="checkbox"/>	Ø10	Ø18					
HxL (mm)	Ø60	Ø95	Ø62	Ø60	Ø40	Ø140	Ø75
	3	3	2	2	4	2	6
N°	50.014	50.015	50.016	50.017	50.018	50.019	50.020

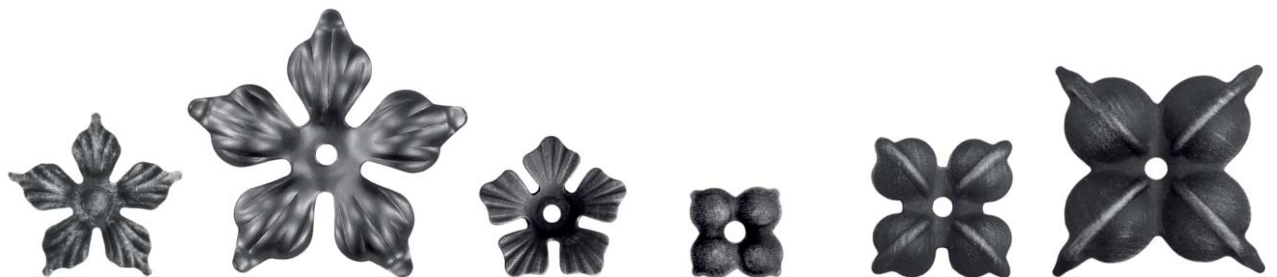

<input type="checkbox"/>		Ø10	Ø10			
HxL (mm)	Ø90	Ø135	Ø85	Ø45	Ø70	Ø115
	2	2	2	1,5	1,5	1,5
N°	50.021	50.021.01	50.022	50.023	50.024	50.025

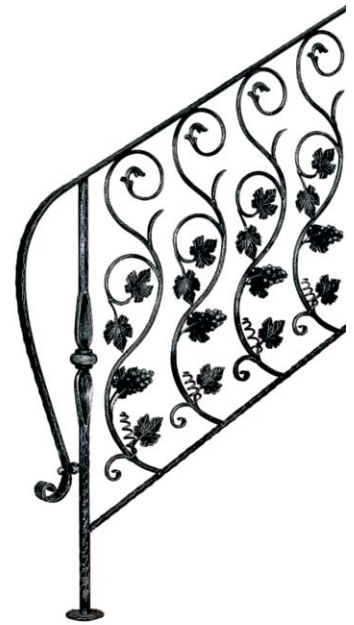
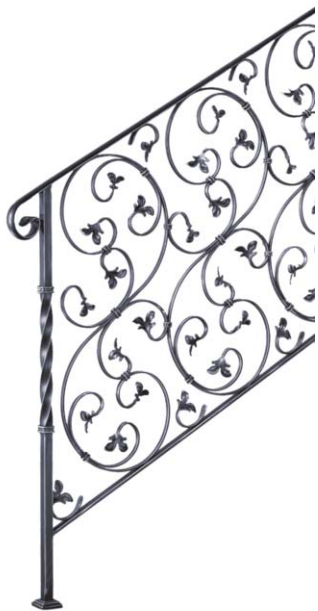

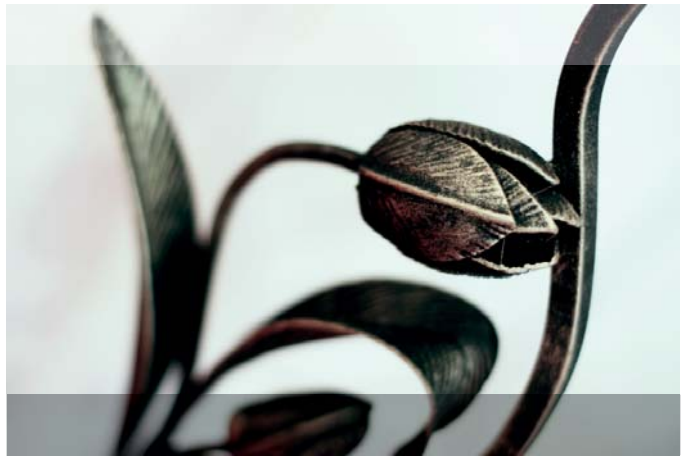



<input type="checkbox"/>				Ø46	Ø70	Ø115
HxL (mm)	Ø65	Ø95	Ø120	5	10	20
	3	3	3	1	1,5	1,5
N°	50.026	50.027	50.028	50.029	50.030	50.031



<input type="checkbox"/>			Ø75	Ø60 new	Ø75 new
HxL (mm)	Ø80	Ø60	45	50	55
	1,5	1,5	2	1,5	1,5
N°	50.032	50.033	50.034	50.035	50.036



HxL (mm)	Ø80	Ø120	Ø90	Ø120	Ø120 new	Ø150 new
	2,5	2,5	4	4	1	2
N°	50.040	50.041	50.042	50.043	50.044	50.045

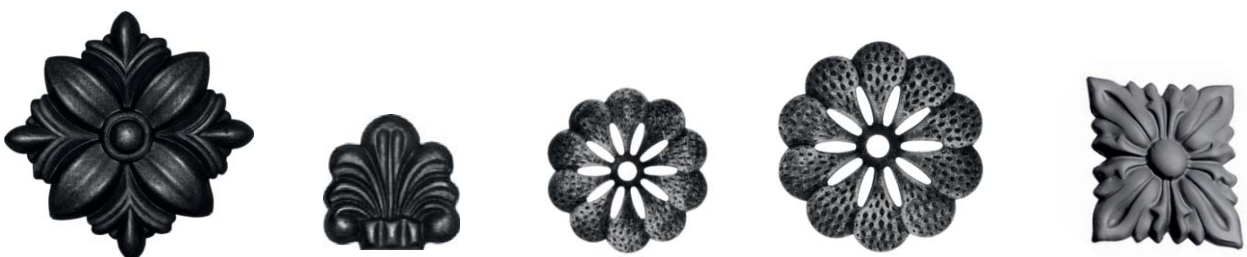

HxL (mm)	Ø140 new	55x55 new	Ø68	Ø95	80x75
	2	4	1,5	2	2
N°	50.046	50.047	50.048	50.049	50.050



HxL (mm)	Ø100	Ø95	Ø100	Ø85	Ø115
	2	2	2	2	2
N°	50.051	50.052	50.053	50.054	50.055



HxL (mm)	Ø115 new	Ø95 new
	2	2
N°	50.056	50.057









HxL (mm)	Ø60	Ø45	Ø30	450x160
	1,5	1,5	1,5	
N°	50.095	50.096	50.097	50.100









HxL (mm)	100x70	240x140	60x45	240x140	55x30
N°	50.101	50.102	50.103	50.104	50.105

							
HxL (mm)	70x50	50x40	45x33	300x70	50x50	70x50	50x40
	2	2	1		1,5	2	2
N°	50.106	50.107	50.108	50.109	50.110	50.111	50.112

							
HxL (mm)	400x150	460x170	480x210	490x250	270 x 40	270x40	70x80
	2,5	2,5	2,5	2,5			
N°	50.113	50.114	50.115	50.116	50.117	50.118	50.119

						
HxL (mm)	190x115	140x125	135x50	85x40	65x30	115x45
				3	3	3
N°	50.120	50.120.01	50.121	50.122	50.122.01	50.123

						
HxL (mm)	140x85	100x90	100x40	500x420	60x115	45x90
N°	50.124	50.124.01	50.125	50.126	50.130	50.131



HxL (mm) 145x90
2

N° 50.132



115x70
2

N° 50.133



85x50
2

N° 50.134



260 **new**
2

N° 50.135



220 **new**
2

N° 50.136



195 **new**
2

N° 50.137



160 **new**
2

N° 50.138



HxL (mm) 420x220

N° 50.140



380x150

N° 50.141



340x140

N° 50.142



130x40
3

N° 50.143



115x40
3

N° 50.143.01



90x30
3

N° 50.143.02



□ Ø20x75x20

N° 50.144



□ Ø20x75x65

N° 50.145



□ Ø20x75x75

N° 50.146



HxL (mm) 175x95
2

N° 50.150



145x75
2

N° 50.151



100x55
2

N° 50.152



Ø25x70

N° 50.153



Ø20x56

N° 50.154



65x45
5

N° 50.155



HxL (mm) 150x150
2,5

N° 50.156



115x125
2

N° 50.157



85x95
2

N° 50.158



70x70
1,5

N° 50.159



105x100
1,5

N° 50.160



75x75
1,5

N° 50.161



50x50
1,5

N° 50.162



160x60

N° 50.165



120x60

N° 50.166



200x70

N° 50.170



Ø12x300x190

N° 50.175



Ø12x300x190

N° 50.176



135x35

N° 50.180



HxL (mm) 130x195

2

N° 50.181



HxL (mm) 155x105

2

N° 50.182



HxL (mm) 115x75

2

N° 50.183



HxL (mm) 235x230

2,5

N° 50.184



HxL (mm) 210x180

2,5

N° 50.185



HxL (mm) 140x110

2,5

N° 50.186



HxL (mm) 85x45

5

N° 50.187



HxL (mm) 410x165

N° 50.188



HxL (mm) 275x105

N° 50.189



HxL (mm) 250x45

2

N° 50.190



HxL (mm) 160x110

2

N° 50.191



HxL (mm) 225x60

4

N° 50.192



HxL (mm) 210x135

4

N° 50.193



HxL (mm) 210x135

4

N° 50.194



HxL (mm) 210x75

3

N° 50.195



HxL (mm) 200x110

3

N° 50.196



HxL (mm) 200x110

3

N° 50.197



HxL (mm) 500

2

N° 50.198



HxL (mm) 305

2

N° 50.199



HxL (mm) 200x115

2

N° 50.200



HxL (mm) 145x90

2

N° 50.201



HxL (mm)	330x130	80x80	130x60	205x195	175x166	150x142
	2 new	2 new	2 new	2 new	2 new	2 new
N°	50.202	50.203	50.204	50.208	50.209	50.210



HxL (mm)	120x140	90x105	60x70	340x70	340x55
	2,5	2,5	2,5		
N°	50.211	50.212	50.213	50.214	50.215



HxL (mm)	190x200 new	165x155 new	130x125 new	100x95 new	125x35 new
	2	2	2	2	2
N°	50.216	50.217	50.218	50.219	50.220



HxL (mm)	270x65	240x60	210x55	180x45	50xØ30	350x315 new	350x315 new
	1,5 new	1,5 new	1,5 new	1,5 new	new	1,5	1,5
N°	50.221	50.222	50.223	50.224	50.225	50.226	50.227



new **new**

HxL (mm) 130x55 130x55
2 2

N° 50.229 50.230



new

130x135
2

50.231



new

130x135
2

50.232



new

155x95
2

50.233



new

155x95
2

50.234



new

HxL (mm) 200x140
2,5

N° 50.236



new

190x70
2,5

50.237



new

260x150
2,5

50.238



new

240x70
2,5

50.239



new

370x120
2,5

50.240



new

HxL (mm) 350x60
2,5

N° 50.241



new

350x60
2,5

50.242



new

280x85
2,5

50.243



new

250x50
2,5

50.244



new

250x50
2,5

50.245



HxL (mm)	300x260	300x260
	2,5	2,5
N°	50.251	50.252



HxL (mm)	170x190	170x190
	2,5	2,5
N°	50.253	50.254



HxL (mm)	200x210	200x210
	2,5	2,5
N°	50.255	50.256



HxL (mm)	270x100	270x100
	2,5	2,5
N°	50.257	50.258



HxL (mm)	100x60	100x80	100x50	100x50	80x80	80x80	115x40	115x40
	3	3	2,5	2,5	2	2	2	2
N°	51.001	51.002	51.003	51.004	51.005	51.006	51.007	51.008



HxL (mm)	125x80	125x80	100x90	100x90	80x60	80x60	120x100	120x100
	2	2	2	2	2	2	2	2
N°	51.009	51.010	51.015	51.016	51.017	51.018	51.019	51.020



HxL (mm)	120x100 new	117x92 new	190x60	190x60	110x40	110x40	90x30	90x30
	2	2	2	2	2	2	2	2
N°	51.021	51.022	51.059	51.060	51.061	51.062	51.063	51.064



HxL (mm)	80x60	80x60	130x60 new	130x60 new	55x70	55x70
	2	2	3	2	2	2
N°	51.069	51.070	51.071	51.072	51.073	51.074



HxL (mm)	110x75	110x75	110x75 new	108x45	110x47	155x65
	2	2	3	2	2	2
N°	51.077	51.078	51.079	51.080	51.081	51.082



HxL (mm)	100x72	160x85	160x85	130-160x85 new	230x67	160x40
	2	2	2	2	5	2,5
N°	51.083	51.084	51.085	51.089	51.090	51.097



HxL (mm) 280x50

2,5

N° **51.098**



105x50

3

N° **51.099**



100x70

4

N° **51.100**



135x32

3

N° **51.101**



165x60

3

N° **51.102**



HxL (mm) 165x70

4

N° **51.103**



300x70

4

N° **51.104**



275x50

4

N° **51.105**



430x110

6

N° **51.106**



330x100

5

N° **51.107**



330x100

5

N° **51.108**



364x100

2

N° **51.108.01**

new



180x50

5

N° **51.109**



HxL (mm) 150x80

1,5

N° **51.110**



100x80

4

N° **51.111**



100x80

4

N° **51.112**



160x90

5

N° **51.113**



160x90

5

N° **51.114**



HxL (mm) 215x175

4

N° **51.115**



215x175

4

N° **51.116**



255x155

4

N° **51.117**



255x155

4

N° **51.118**



HxL (mm) 270x145 270x145

2 2

N° 51.119 51.120

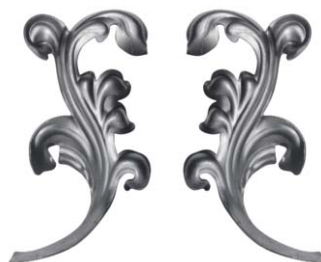

200x95 200x95

2 2

N° 51.121 51.122



295x175 295x175

2 2

N° 51.123 51.124



HxL (mm) 230x135 230x135

2 2

N° 51.125 51.126



164x130 164x130

2 2

N° 51.127 51.128



240x140 240x140

2 2

N° 51.129 51.130



HxL (mm) 245x130

2

N° 51.131



242x170

2

N° 51.132



180x170

2

N° 51.133



180x170

2

N° 51.134



HxL (mm) 260x75

2

N° 51.140



240x85

2

N° 51.141



240x85

2

N° 51.142



255x70

2

N° 51.143



235x85

2

N° 51.144



HxL (mm)	290x56	290x56 new	240x70 new	240x60 new	190x50 new
	2	2	2	2	2
N°	51.145	51.146	51.147	51.148	51.149



HxL (mm)	120x50	120x50	110x95	110x95
	2	2	2	2
N°	51.151	51.152	51.153	51.154



HxL (mm)	230x85	230x85	220x80	220x80	198x77 new	198x77 new
	2	2	2	2	1	1
N°	51.155	51.156	51.157	51.158	51.159	51.160



HxL (mm) 130x75
4

N° 51.200



HxL (mm) 190x125
5

N° 51.201



HxL (mm) 330x260
5

N° 51.202



HxL (mm) 210x120
5

N° 51.203



HxL (mm) 210x120
5

N° 51.204



HxL (mm) 183x173
2

N° 51.205



HxL (mm) 183x173
2

N° 51.206



HxL (mm) Ø160
2

N° 51.235



HxL (mm) 85x75
2

N° 51.236



HxL (mm) 170x70
2

N° 51.237



HxL (mm) 230x95
2

N° 51.238



HxL (mm) 250x120
2

N° 51.239



HxL (mm) 340x210
2

N° 51.240



HxL (mm) 340x210
2

N° 51.241



HxL (mm) 860x184
1

N° 51.244



HxL (mm) 860x184
1

N° 51.245



HxL (mm) 215x73
1

N° 51.242



HxL (mm) 215x73
1

N° 51.242



HxL (mm) 310x100
1

N° 51.410



HxL (mm) 450x300
1

N° 51.412

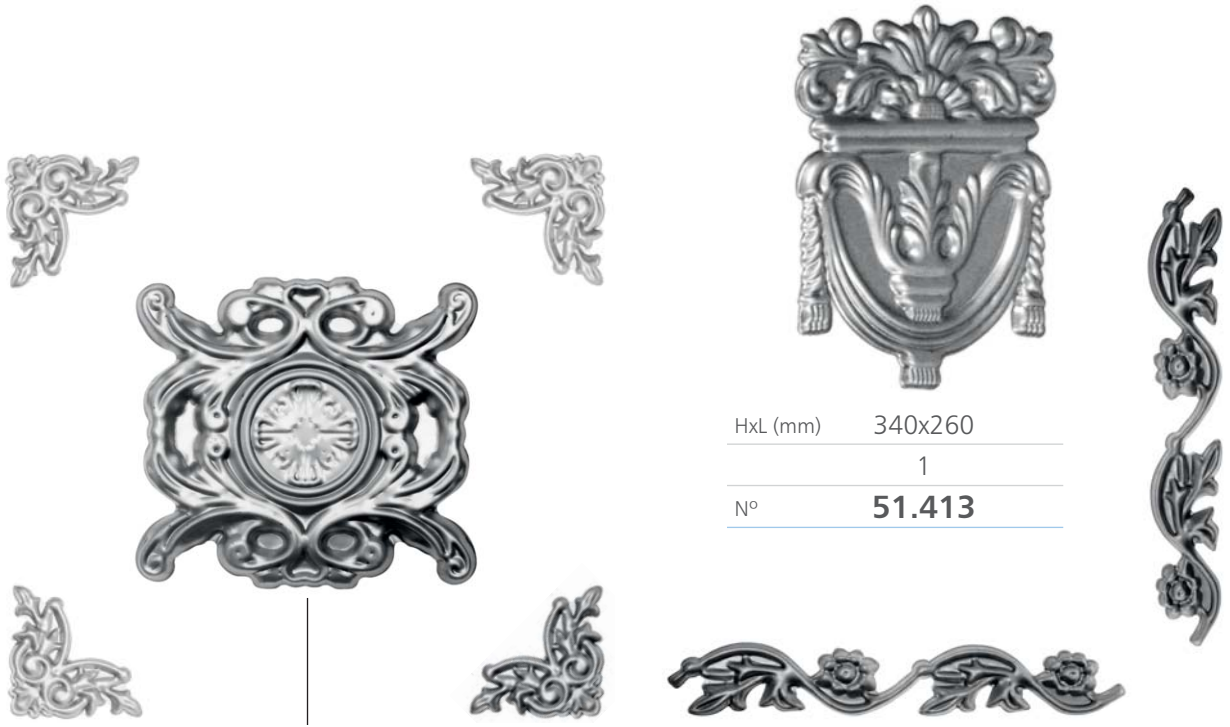

HxL (mm)	340x260
	1
N°	51.413

HxL (mm)	255x230	146x146	410x65	410x65
	1	1	1	1
N°	51.411	51.420	51.426	51.425



HxL (mm)	320x300	430x310	170x340	170x170	110x110
	1	1	1	1	1
N°	51.414	51.415	51.416	51.417	51.418



HxL (mm)	157x178 new	146x146	184x184	145x145	100x100
	1	1	1	1	1
N°	51.419	51.420	51.421	51.422	51.423



HxL (mm) 120x570

290x470

1

1

N° 51.427

51.428



HxL (mm) 400x130

400x130

270x100

270x100

340x140

340x140

1

1

1

1

1

1

N° 51.430

51.431

51.432

51.433

51.434

51.435



HxL (mm) 200x650

200x650

Ø155

180x330 **new**

1

1

1

1

N° 51.440

51.441

51.443

51.444

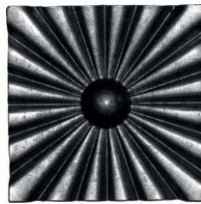

HxL (mm) 205x220 **new**

145x145 **new**

HxL (mm) 72x100 **new**

2

1,5

1

N° 51.445

51.446

N° 51.448



HxL (mm) 80x100 **new**

1

N° 51.449



HxL (mm) 115x155

225x305

225x40

1,5

2

2

N° 51.450

51.451

51.452



HxL (mm)	130x110	130x110
	1	1
N°	51.453	51.454



HxL (mm)	287x210	287x210
	1	1
N°	51.460	51.461

1.15

odlewy ze staliwa • cast steel items • Stalguss • литая сталь • odlitky z lité oceli



HxL (mm)	85x70	85x70	105x95	105x95
	4	4	3	3
N°	52.001	52.002	52.003	52.004



HxL (mm)	270x110	270x110
	4	4
N°	52.005	52.006



HxL (mm)	260x135	260x135	140x65	140x65	150x130	150x130
	4	4	4	4	4	4
N°	52.007	52.008	52.009	52.010	52.011	52.012



HxL (mm)	140x110	140x110	190x160	190x160	155x140	155x140
	4	4	4	4	4	4
N°	52.013	52.014	52.015	52.016	52.017	52.018



HxL (mm) 250x150 250x150
4 4

N° 52.019 52.020



HxL (mm) 220x105 220x105
4 4

N° 52.021 52.022



HxL (mm) 180x85 180x85
4 4

N° 52.023 52.024



HxL (mm) 165x105 165x105
4 4

N° 52.025 52.026



HxL (mm) 200x125 200x125
4 4

N° 52.027 52.028



HxL (mm) 215x140
4

N° 52.029



HxL (mm) 170x75
4

N° 52.030



HxL (mm) 220x180
4

N° 52.031



HxL (mm) 185x80
4

N° 52.032



HxL (mm) 245x125
4

N° 52.033



HxL (mm) 235x105
4

N° 52.034



HxL (mm) 225x130 225x130
4 4

N° 52.035 52.036



HxL (mm) 155x55 155x55
4 4

N° 52.037 52.038



HxL (mm) 230x65 230x65
4 4

N° 52.039 52.040



HxL (mm)	150x65	150x65	115x55	190x60	175x50	155x90
	4	4	4	4	4	4
N°	52.041	52.042	52.043	52.044	52.045	52.046



HxL (mm)	135x75	160x45	240x150	240x150	170x138	170x138
	4	4	4	4	4	4
N°	52.047	52.048	52.049	52.050	52.051	52.052



HxL (mm)	145x50	175x50	215x50	Ø160	Ø90x60
	6	6	8	4	4
N°	52.053	52.054	52.055	52.130	52.131



<input type="checkbox"/>	Ø8					
HxL (mm)	Ø90	Ø90	Ø115	85x80	Ø100	92x78
	3	5	5	3	3,5	4
N°	52.132	52.133	52.134	52.135	52.136	52.137

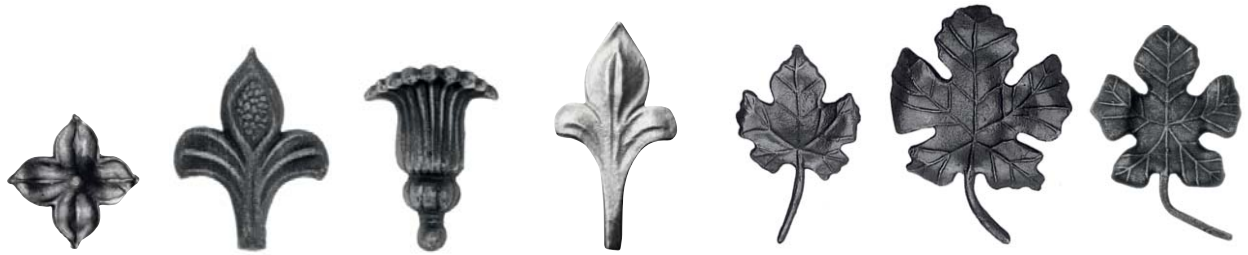

HxL (mm)	Ø55	106x78	93x67	140x78	125x75	155x110	122x80
	4	4	4	4	3	4	4
N°	52.139	52.140	52.141	52.142	52.201	52.202	52.203



HxL (mm)	170x100	200x140	180x28	160x43	Ø90	Ø55
			Ø5	Ø5	8	8
N°	52.211	52.212	52.216	52.217	52.300	52.301



HxL (mm)	Ø70	Ø90	85x70	Ø100	95x75
	8	8	8	8	8
N°	52.304	52.305	52.306	52.307	52.309



HxL (mm)	Ø130	340x210	340x210	220x130	220x130
		5	5	4	4
N°	52.310	52.400	52.401	52.402	52.403



HxL (mm)	185x90	165x125	195x100	220x145
	8	8	8	12
N°	52.404	52.405	52.406	52.420

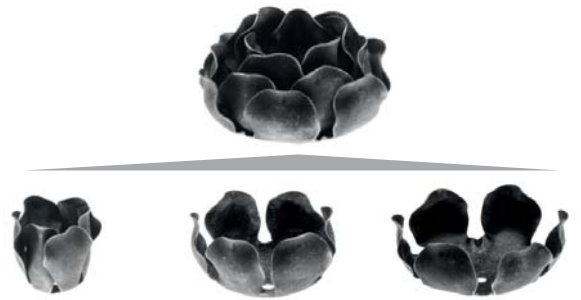

HxL (mm)	Ø80	Ø80x17	Ø155x27	Ø40x40	Ø55x35	Ø65x30
	0,5	0,5	1	0,5	0,5	0,5
N°	53.000	53.001	53.002	53.003	53.004	53.005



HxL (mm)	Ø90x70	Ø40x42
	0,6	0,6
N°	53.006	53.007



HxL (mm)	85x45	70x35	195x80	57x55	105x95	200x190
	0,5	0,5	0,5	0,6	1	1
N°	53.008	53.009	53.010	53.011	53.012	53.013



HxL (mm)	130x65	90x45	60x110	125x175	100x230 new
	1	1	1	1	1
N°	53.014	53.015	53.016	53.017	53.020

1.16

odlewy z żeliwa • cast iron items • Gusseisenwaren • чугунные элементы • odlitky z litiny



<input type="checkbox"/>	14x14	14x14	14x14	14x14	14x14
HxL (mm)	380x190	400x190	455x200	165x138	280x130
N°	55.001	55.003	55.005	55.006	55.007

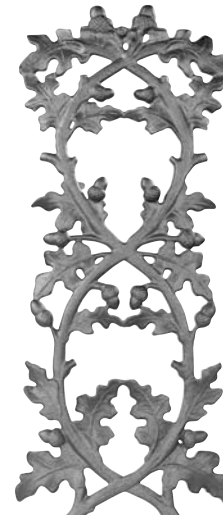

<input type="checkbox"/>	14x14	14x14	280x195/Ø16	680x300	680x300
HxL (mm)	315x220	280x195	280x195/Ø16	680x300	680x300
N°	55.008	55.009	55.010	55.020	55.021

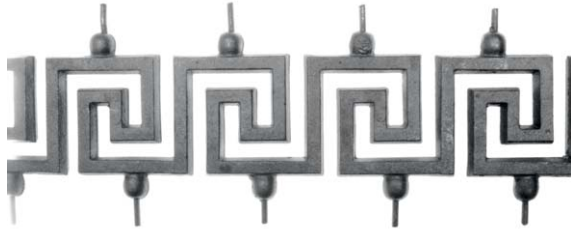

500x100

N°

55.030

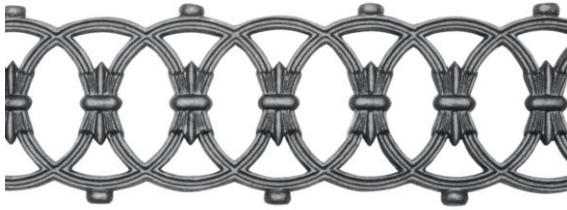

870x150

N°

55.031

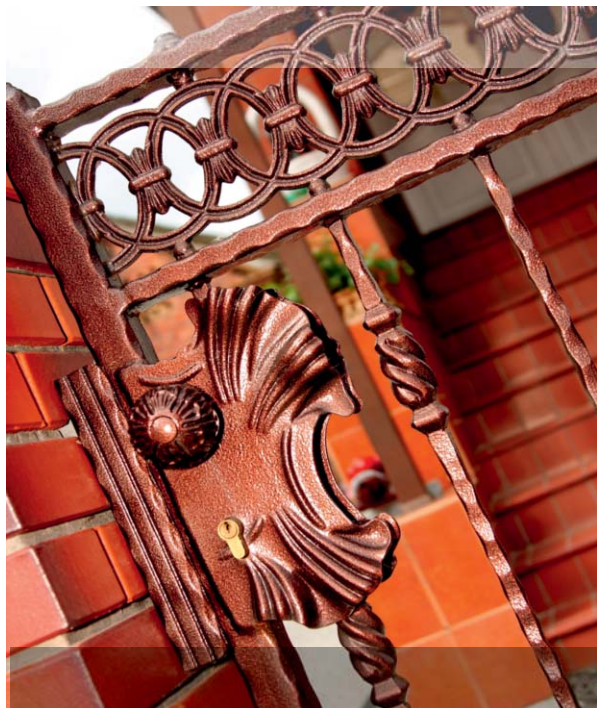

HxL (mm)

Ø120

Ø100

210x110

N°

55.050

55.100

więcej realizacji na:
www.realizacje.postal.pl



HxL (mm)

40x40

50x50

60x60

80x80

100x100

250x160

87

110

135

165

180

N°

55.101

55.102

55.103

55.104

55.105

55.200



Akcesoria do bram i ogrodzeń marki PSG oraz elektronarzędzia



PSG

DEWALT

BOSCH

2.01

wózki i akcesoria • cantilever gate carriages, accessories • Wagen, Zubehör
 • каретки и аксессуары • vodící vozíky a příslušenství



wózek jezdny 80 z dużą płytą
cantilever gate carriage 80, big plate

rolki stalowe / steel wheels

N° **60.000**



wózek jezdny 80
cantilever gate carriage 80

rolki stalowe / steel wheels

N° **60.001**



wózek jezdny 80
cantilever gate carriage 80

rolki stalowe / steel wheels

N° **60.002**



wózek jezdny 80
cantilever gate carriage 80

rolki stalowe / steel wheels

N° **60.003**

rolki plastikowe / plastic wheels

N° **60.000.01**

rolki plastikowe / plastic wheels

N° **60.001.01**

rolki plastikowe / plastic wheels

N° **60.002.01**

rolki plastikowe / plastic wheels

N° **60.003.01**

wózek jezdny 70, rolki metalowe
cantilever gate carriage 70
metal wheel

N° **60.002.70**

wózek jezdny 70, rolki metalowe
cantilever gate carriage 70
metal wheel

N° **60.003.70**

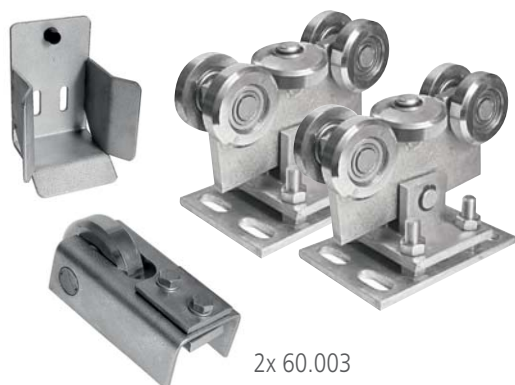

2x 60.003
+ 60.010
+ 60.020

N° **60.00P.80**

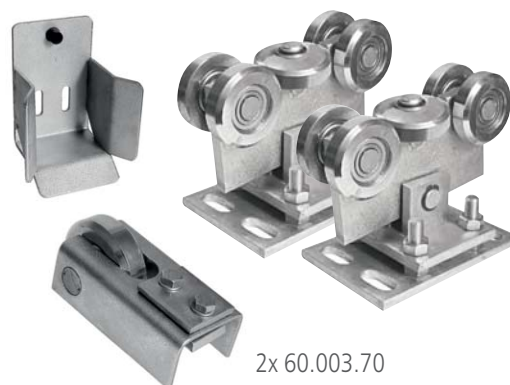

2x 60.003.70
+ 60.010
+ 60.020

N° **60.00P.70**



wózek jezdny 80
cantilever gate carriage 80

rolki stalowe / steel wheels

N° **60.004**



wózek jezdny 80
cantilever gate carriage 80

rolki stalowe / steel wheels

N° **60.005**



wózek jezdny 80
cantilever gate carriage 80

rolki stalowe / steel wheels

N° **60.006**



wózek jezdny 80
cantilever gate carriage 80

rolki stalowe / steel wheels

N° **60.007**

rolki plastikowe / plastic wheels

N° **60.004.01**

rolki plastikowe / plastic wheels

N° **60.005.01**

rolki plastikowe / plastic wheels

N° **60.006.01**

rolki plastikowe / plastic wheels

N° **60.007.01**

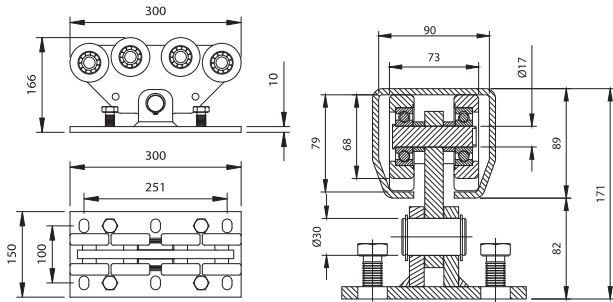

wózek jezdny 68, rolki stalowe, do szyny 100x89x5
cantilever gate carriage 68, steel wheels

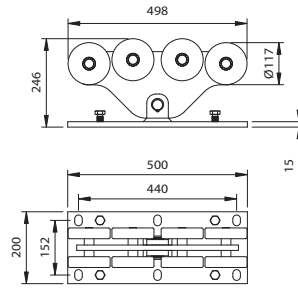

wózek jezdny 117, rolki stalowe, do szyny 140x140x6
cantilever gate carriage 117, steel wheels

N° **60.350.8P**

60.350.8G



100x89x5, H=6000



140x140x6, H=6000

N° **60.345P**

60.345G

na zamówienie szyna max do H=13 000 mm

na zamówienie szyna max do H=13 000 mm



rolka najazdowa
guide wheel



N° **60.010**



uchwyt najazdu 80
cup for rail 80

60.019



uchwyt najazdu
cup for rail

60.020



uchwyt najazdu 80
cup for rail 80

60.021



uchwyt bramy 40
cup for gate 40

60.022



uchwyt bramy 60
cup for gate 60

60.023



uchwyt bramy 80
cup for gate 80

60.024



prowadzenie górne stałe
fixed gate guide

60.030



prowadzenie górne regulowane
adjustable, gate guide

60.030.01

N°



przewodzenie górne regulowane
adjustable, gate guide

N° **60.031**



new

zderzak zewnętrzny
gate stopper

100x80, H95

N° **60.038**



new

zderzak zewnętrzny
gate stopper

100x100, H146

N° **60.039**



Ø25



Ø30



Ø32



Ø35



Ø40



Ø35



Ø40

N° **60.040** **60.040.01** **60.040.02** **60.040.03** **60.040.05** **60.043** **60.049**



listwa zębata stalowa / steel zinc gear racks

L 1000 x 10

L 1000 x 8

N° **60.050** **60.051**



new

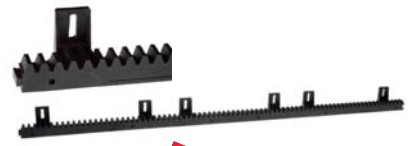

new

listwa zębata tworzywo / plastic gear racks

3x L 333 x 18

3x L 333 x 20

L 1000 x 18

L 1000 x 20

N° **60.055** **60.055.01** **60.056** **60.056.01**



70 x 70 x 27,5 x 4

6000

N° **60.070**



80 x 80 x 27,5 x 5

6000

N° **60.080**

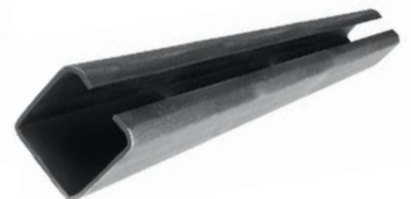

80 x 80 x 27,5 x 5

7000

N° **60.080.01**



type	„V”	„O”	„O”	„T”
N°	60.100	60.102	60.103.01	60.104
N°	60.101	60.103		60.105

Ø 70 x 20 Ø 70 x 16,5 Ø 90 x 3/4” Ø 70 x 20

Ø 90 x 20 Ø 90 x 1/2” Ø 90 x 20



type	„V”	„O”	„O”	„T”
N°	60.106	60.108	60.109.01	60.110
N°	60.107	60.109		60.111

Ø 75 x 22 Ø 75 x 1/2” Ø 90 x 3/4” Ø 70 x 22

Ø 90 x 22 Ø 90 x 1/2” Ø 90 x 22



type	„V” new	„T” new
N°	60.120.70	60.122.80
N°	60.120.90	

Ø 70 x 20 Ø 70 x 20

Ø 90 x 20



mm	Ø 25 new	Ø 44 new	Ø 25 new	Ø 44 new
N°	60.201.25	60.201.44	60.202.25	60.202.44

M8 M12 M8 M12



zawias regulowany
adjustable hinges

M20, 100x100x4

N° **61.000**



zawias do spawania
welding hinges

M16

N° **61.001**



zawias regulowany
adjustable hinges

M18, L 130 mm

N° **61.003**



zawias do wmurowania
built-in hinges

M16

N° **61.005**

N° **61.002**

M20

M20, L 130 mm

N° **61.004**

N° **61.006**



zawias regulowany
adjustable hinges **new**

M16, 155x80x4

N° **61.007**



zawias regulowany
adjustable hinges **new**

M20, 160x105x6

N° **61.008**



zawias do spawania
welding hinges

M18

N° **61.010**



zawias regulowany
adjustable hinges

M16

N° **61.012**



zawias regulowany z szyldem
adjustable hinges with shield

M16, 80 x 80 x 3

N° **61.016**



zawias regulowany z szyldem
adjustable hinges with shield

M16, 80 x 80 x 3

N° **61.018**

N° **61.011**

M22

N° **61.013**

M20

M20, 100 x 100 x 4

N° **61.017**

M20, 100 x 100 x 4

N° **61.019**



zawias regulowany
adjustable hinges

M20

N° **61.021**



zawias regulowany
adjustable hinges

M18

N° **61.023**



zawias do spawania
welding hinges

M20

N° **61.027**



zawias do spawania
welding hinges

M18

N° **61.029**

N° **61.024**

M22

N° **61.028**

M24

N° **61.030**

M22



zawias do wmurowania
built-in hinges

M20

N° **61.040**



zawias do wmurowania
built-in hinges

M18

N° **61.042**



zawias, kąt otwarcia 180°
hinges, open angle 180°

N° **61.051**

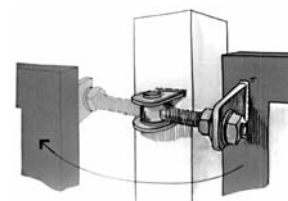

61.051, 61.052

N° **61.041**

M24

N° **61.043**

M22

N° **61.052**



zawias regulowany do wspaw.
adjustable welding hinges

Ø30 M20 **new**
N° **61.053**



zawias regulowany do wspaw.
adjustable welding hinges

Ø30 M20 **new**
N° **61.055**



łącznik zawiasu
connector

Ø28,5 H55/35x35 **new**
N° **61.057**



zawias dolny
bottom hinges

Ø20 H89/60x60/15 **new**
N° **61.059**

N° **61.054**

Ø35 M24 **new**

N° **61.056**

Ø35 M24 **new**

Ø33,5 H60/40x40 **new**
N° **61.058**



zawias regulowany
adjustable hinges

M16, 120x75 **new**
N° **61.061**



zawias regulowany
adjustable hinges

M20, 160x85 **new**
N° **61.063**



zawias regulowany
adjustable hinges

z kulą / with ball
Ø24+K M12, 140x40 **new**
N° **61.064**



zawias dolny
bottom hinges

z kulą / with ball
Ø30+K M18, 160x85 **new**
N° **61.066**

N° **61.062**

M20, 160x85 **new**

Ø27+K M16, 180x50 **new**
N° **61.065**



stoper
gate stop

Ø 90 x 90

N° **61.090**



stoper do przykrecenia
screw fixing gate stop

157 x 130 x 44

N° **61.091**



listwa antywłamaniowa
anti-theft rack

H 33 x L 2000 / 3

N° **61.095**



□	Ø20	Ø29	Ø20	Ø24	Ø30	Ø30
H (mm)	100	130	100	122	146	230
N°	61.100	61.101	61.102	61.103	61.104	61.105



□	Ø27
H (mm)	145
N°	61.106



Ø	H	N°
12	60	61.112
16	66	61.116
20	70	61.120
24	80	61.124
27	90	61.127
30	100	61.130
35	120	61.135
40	120	61.140



Ø	H	N°
20	70	61.120.01
24	80	61.124.01
27	90	61.127.01
30	100	61.130.01
35	120	61.135.01
40	120	61.140.01



Ø	H	N°
16/20	120	61.116.02
20/25	140	61.120.02
23/28	200	61.124.02

new

□	Ø35
H (mm)	190
N°	61.107

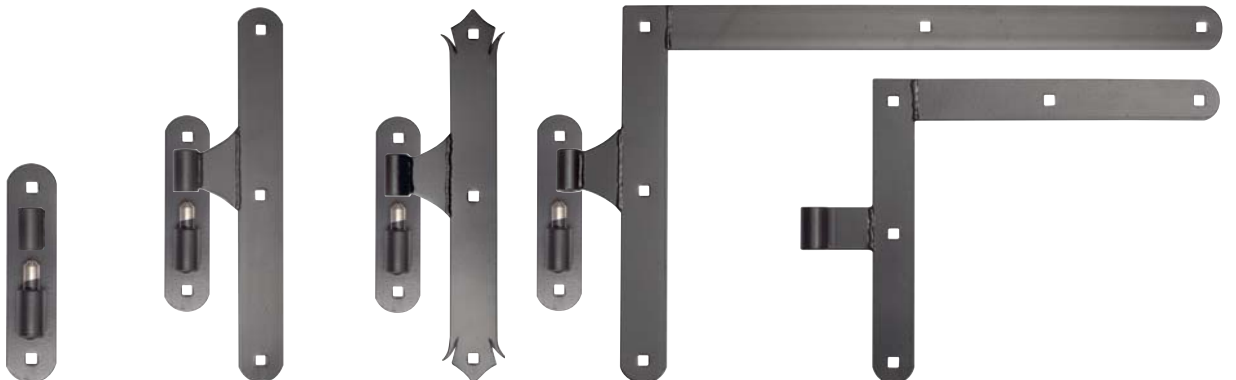

□	Ø27	Ø27	Ø27	50x5	35x4
H (mm)	210x90	400x50	400x50	400x650	250x290
N°	61.202	61.211	61.212	61.221	61.222

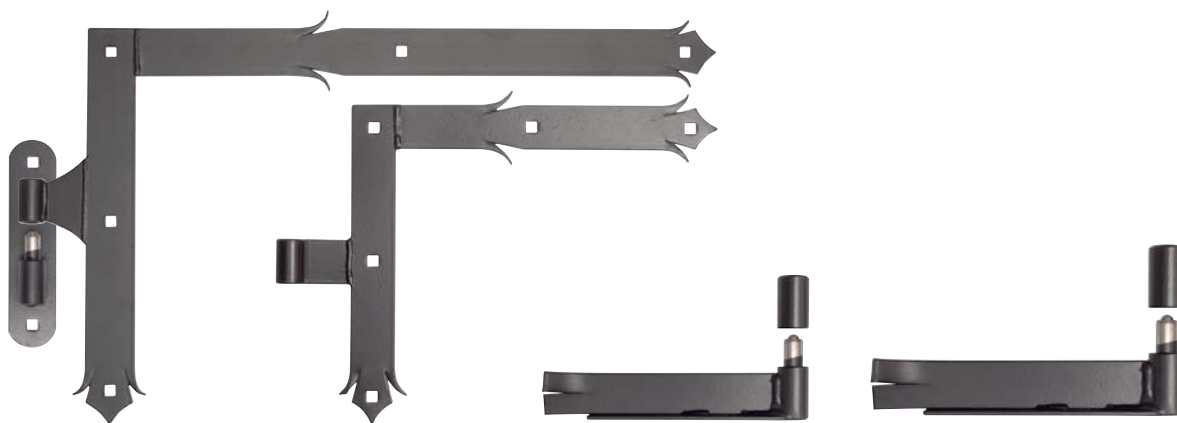

<input type="checkbox"/>	50x5	35x4	Ø27	Ø35
H (mm)	400x650	250x290	220	240
N°	61.223	61.224	61.231	61.232

H	L	Ø	N°
400	35	14	61.251
600	35	14	61.252
800	40	18	61.253
1000	50	18	61.254
1150	60	20	61.255
500	35	14	61.256
700	50	18	61.257

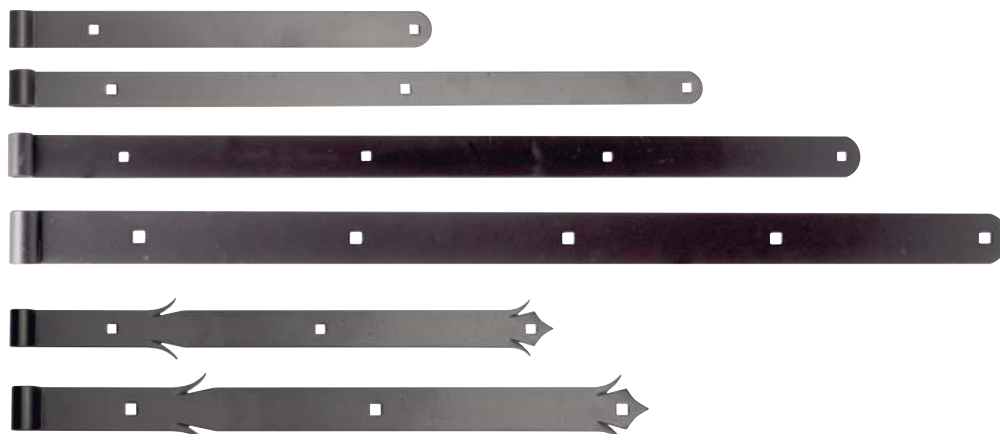

<input type="checkbox"/>	150x35	200x40	220x50	220x60	150x35
	Ø14	Ø18	Ø18	Ø20	Ø14
N°	61.261	61.262	61.263	61.264	61.265

Ø	H	L	N°
14	150	35	61.271
18	200	40	61.272
18	220	50	61.273
20	270	60	61.274

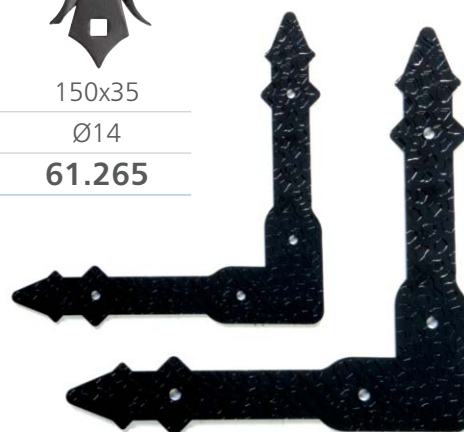

<input type="checkbox"/>	150x150	200x200
	3	3
N°	61.300	61.301



185x160
3

N° **61.302**



250x210
3

N° **61.303**



203x100
3

N° **61.304**



350x200
3

N° **61.305**



350x200
3

N° **61.306**



525x225
3

N° **61.307**



525x225
3

N° **61.308**



148x215 **new**
3

N° **61.314**



208x352 **new**
3

N° **61.315**



208x352 **new**
3

N° **61.316**

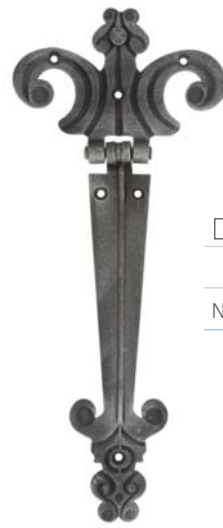

405x170
5

N° **61.310**

270x500 **new**
3

N° **61.317**

270x500 **new**
3

N° **61.318**



2.02

daszki i zaślepki • post tops and stoppers • Deckel und Verschlusskappen
• навесы и заглушки • krytky a záslepky



□	H	N°
20x20	1	62.002
30x30	1	62.003
40x40	1	62.004
50x50	1	62.005
60x60	1	62.006
80x80	1	62.008
100x100	1	62.010
120x120	1	62.012
150x150	1	62.015
200x200	1	62.020



□	H	N°
20x20	1	62.002.01
30x30	1	62.003.01
40x40	1	62.004.01
50x50	1	62.005.01
60x60	1	62.006.01
70x70	1	62.007.01
80x80	1	62.008.01
90x90	1	62.009.01
100x100	1	62.010.01
110x110	1	62.011.01
120x120	1	62.012.01
160x160	1	62.016.01



□	H	N°
40x40	40	62.004.04
50x50	50	62.005.05
50x50	60	62.005.06
60x60	50	62.006.05
60x60	60	62.006.06
60x60	80	62.006.08
70x70	60	62.007.06
70x70	70	62.007.07
80x80	60	62.008.06
80x80	80	62.008.08
90x90	80	62.009.08
90x90	90	62.009.09
100x100	60	62.010.06
100x100	80	62.010.08
100x100	100	62.010.10
120x120	80	62.012.08
120x120	100	62.012.10
120x120	120	62.012.12



∅	N°
42	62.031
48	62.032
60	62.033
77	62.034
90	62.035
100	62.036



□	H	N°
60x60	90	62.106
80x80	120	62.108
100x100	140	62.110
120x120	170	62.112
150x150	200	62.115



∅	∅ kula	N°
42	60	62.042.06
48	60	62.048.06
60	60	62.060.06
60	80	62.060.08
72	80	62.072.08
77	60	62.077.06
77	80	62.077.08
80	60	62.080.06
80	80	62.080.08
90	90	62.090.09
100	80	62.100.08
100	100	62.100.10



∅	N°
42	62.042
48	62.048
60	62.060
72	62.072
77	62.077
80	62.080
90	62.090
100	62.100



∅	H	N°
180	150/4	62.101
155	145/4	62.102
130	145/4	62.103
100	120/4	62.104



□	H	N°
20x30	1	62.123
20x40	1	62.124
30x40	1	62.134
30x50	1	62.135
30x60	1	62.136
40x60	1	62.146
40x80	1	62.148
50x100	1	62.151



∅	N°
30	62.163
40	62.164
50	62.165
60	62.166
70	62.167
90	62.169
110	62.171



□	H	N°
40x40	1	62.184
50x50	1	62.185
60x60	1	62.186
70x70	1	62.187
80x80	1	62.188
90x90	1	62.189
100x100	1	62.190
120x120	1	62.192



□	N°
15x15	62.200
16x16	62.201
20x20	62.202
25x25	62.203
30x30	62.204
35x35	62.206
40x40	62.207
45x45	62.208
50x50	62.209
60x60	62.210
70x70	62.211
80x80	62.212
100x100	62.213
120x120	62.214



□	N°
15x15	62.200.01
16x16	62.201.01
20x20	62.202.01
25x25	62.203.01
30x30	62.204.01
35x35	62.206.01
40x40	62.207.01
45x45	62.208.01
50x50	62.209.01
60x60	62.210.01
70x70	62.211.01
80x80	62.212.01
100x100	62.213.01
120x120	62.214.01



□	N°
15x25	62.221
18x30	62.222
20x30	62.223
20x40	62.224
25x40	62.226
27x40	62.227
30x50	62.228
30x60	62.229
40x60	62.230
40x80	62.231
40x100	62.232
50x100	62.234
60x80	62.235
60x100	62.236
60x120	62.237



□	N°
15x25	62.221.01
18x30	62.222.01
20x30	62.223.01
20x40	62.224.01
25x40	62.226.01
27x40	62.227.01
30x50	62.228.01
30x60	62.229.01
40x60	62.230.01
40x80	62.231.01
40x100	62.232.01
50x100	62.234.01
60x80	62.235.01
60x100	62.236.01
60x120	62.237.01



Ø	N°
16	62.240
18	62.241
20	62.242
25	62.243
30	62.244
32	62.245
35	62.246
40	62.247
43	62.248
50	62.249
60	62.250
70	62.251
76	62.252
1/2"	62.257
3/4"	62.258
1"	62.259
1 1/4"	62.260
1 1/2"	62.261
2"	62.262
2 1/2"	62.263



□	Ø	N°
30x30	30	62.303.03
40x40	40	62.304.04
50x50	50	62.305.05
60x60	60	62.306.06
80x80	70	62.308.07
100x100	80	62.310.08



Ø daszek	Ø kula	N°
33	30	62.333.03
42	40	62.342.04
48	50	62.348.05
60	60	62.360.06
77	70	62.377.07
90	70	62.390.07



□	N°
M6	62.406
M8	62.408
M10	62.410
M12	62.412
M14	62.414
M16	62.416

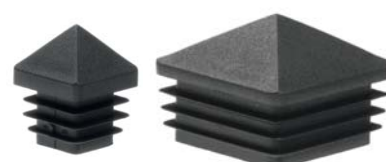

□	N°
20x20	62.502
40x40	62.504
50x50	62.505
60x60	62.506
70x70	62.507
80x80	62.508
100x100	62.510

2.03

klamki i szyldy • door handles and shields • Griffe und Schilder
• ручки и накладки • kliky a štítky



□ 135x75, ocynk galwanizowany
N° 63.001



155x95
63.003



135x75
63.004



□ 160x85
N° 63.005

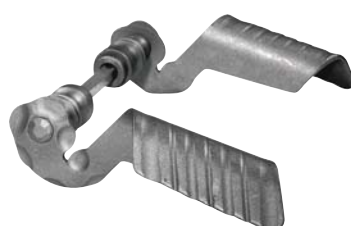

140x75 140x75, ocynk **new**
63.006 63.006.01



135x75, ocynk
63.007



<input type="checkbox"/>	137x75	142x90	121x95	110x90
N°	63.012	63.013	63.014	63.019



<input type="checkbox"/>	Ø60	85x65	70x65	65x65	55x65
N°	63.002	63.008	63.009	63.010	63.011



<input type="checkbox"/>	70x116	90x116	60x70	60x70
N°	63.015	63.016	63.017	63.018



<input type="checkbox"/>	Ø12 / 145x110	120x80 new	130x60 new	130x60 new
N°	63.020	63.021	63.022	63.023



<input type="checkbox"/>	280x90	380x70	460x110
N°	63.024	63.025	63.026



Ø68x85
N° **63.027**



Ø68x110
N° **63.028**



155
N° **63.029**



125
N° **63.030**



150x75 **new**
N° **63.031**



160x90 **new**
N° **63.032**



Ø80x60 **new**
N° **63.033**



140x80 **new**
N° **63.034**



120x80 **new**
N° **63.035**



120x80 **new**
N° **63.036**



165x80 **new**
N° **63.037**



125x85 **new**
N° **63.038**



125x85 **new**
N° **63.039**



HxL (mm)	Ø65	Ø65	Ø50	Ø50
	2	2	2	2
N°	63.040	63.041	63.042	63.043



HxL (mm)	Ø50	Ø50	102x36	102x36
	4	4	3	3
N°	63.044	63.045	63.046	63.047

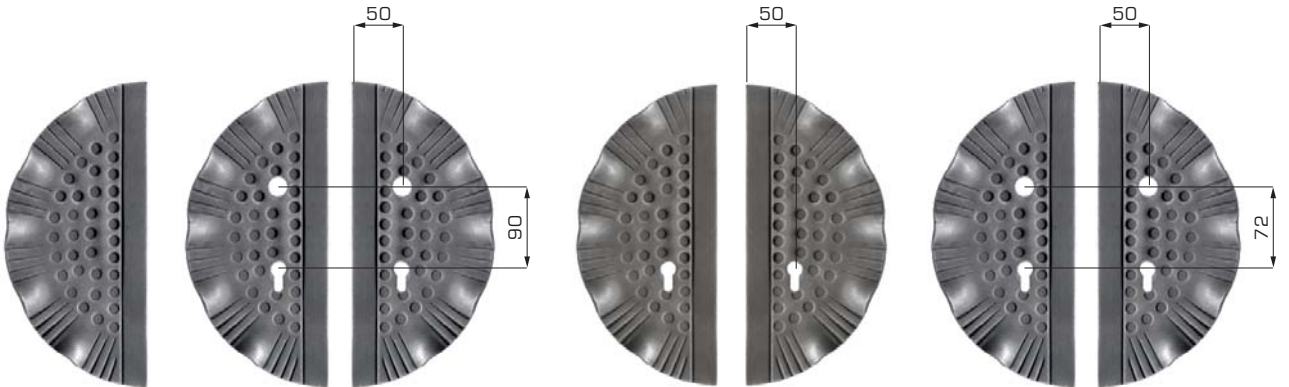

HxL (mm)	275x130	275x130	275x130	275x130	275x130	275x130	
	3	3	3	3	3	3	
N°	63.101.00.00	63.102.90.50	63.103.90.50	63.102.00.50	63.103.00.50	63.102.72.50	63.103.72.50

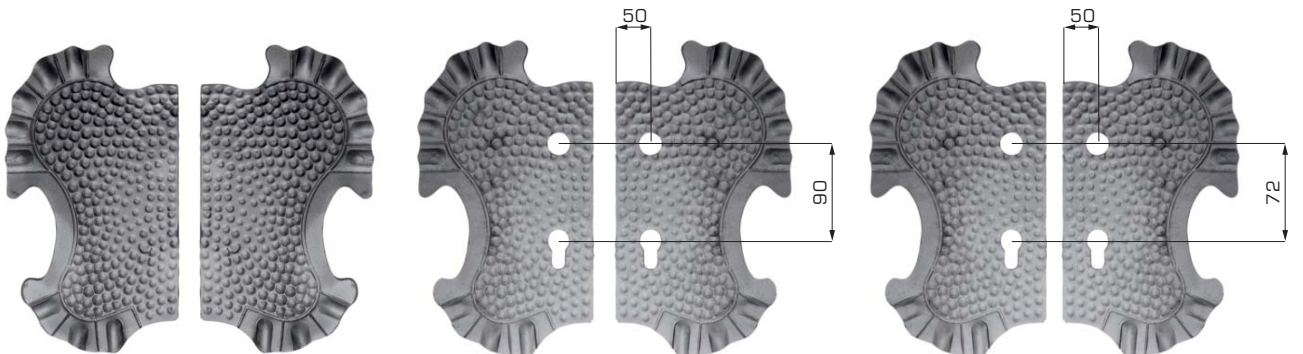

HxL (mm)	290x160	290x160	290x160	290x160	290x160	290x160
	4	4	4	4	4	4
N°	63.104.00.00	63.105.00.00	63.106.90.50	63.107.90.50	63.106.72.50	63.107.72.50

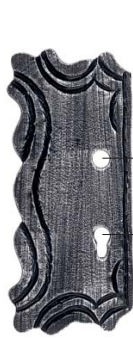

HxL (mm)	305x135	305x135	305x135	305x135	305x135
	4	4	4	4	4
N°	63.108.00.00	63.109.90.50	63.110.90.50	63.109.72.50	63.110.72.50

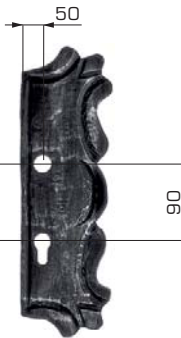

HxL (mm)	295x90	295x90	295x90	295x90	295x90
	4	4	4	4	4
N°	63.111.00.00	63.112.90.50	63.113.90.50	63.112.72.50	63.113.72.50

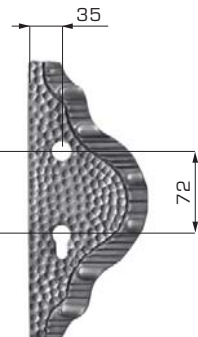
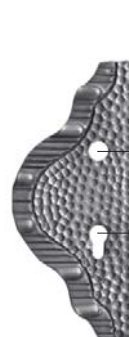
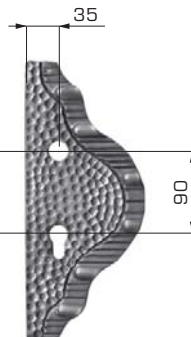
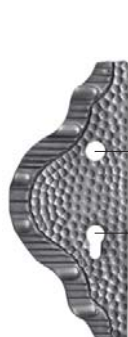

HxL (mm)	295x120	295x120	295x120	295x120	295x120
	3	3	3	3	3
N°	63.114.00.00	63.115.90.35	63.116.90.35	63.115.72.35	63.116.72.35





HxL (mm)	275x160	275x160	275x160	275x160
	3	3	3	3
N°	63.117.00.00	63.118.00.00	63.119.90.50	63.120.90.50

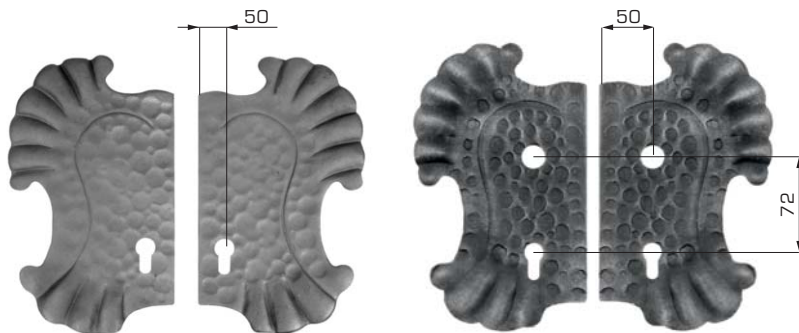

HxL (mm)	275x160	275x160	275x160	275x160
	3	3	3	3
N°	63.119.00.50	63.120.00.50	63.119.72.50	63.120.72.50

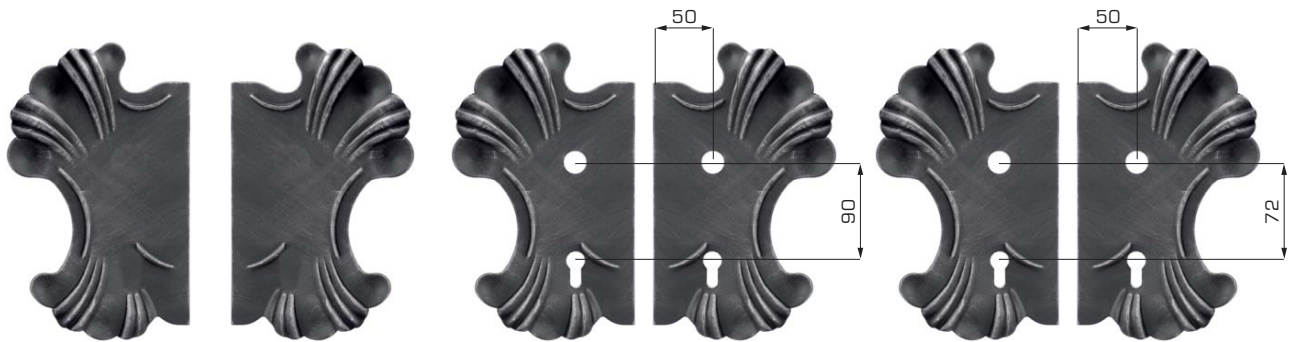
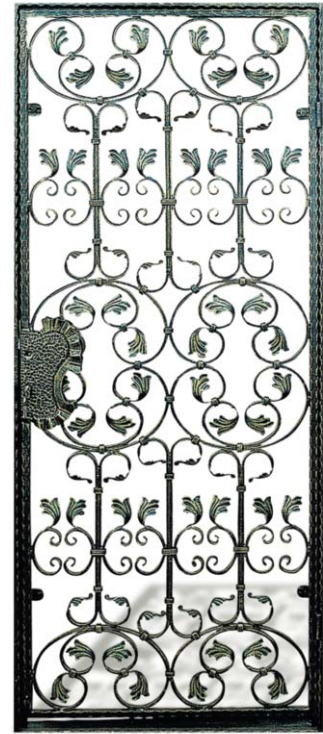

HxL (mm)	270x165	270x165	270x165	270x165	270x165	270x165
	2	2	2	2	2	2
N°	63.125.00.00	63.126.00.00	63.127.90.50	63.128.90.50	63.127.72.50	63.128.72.50

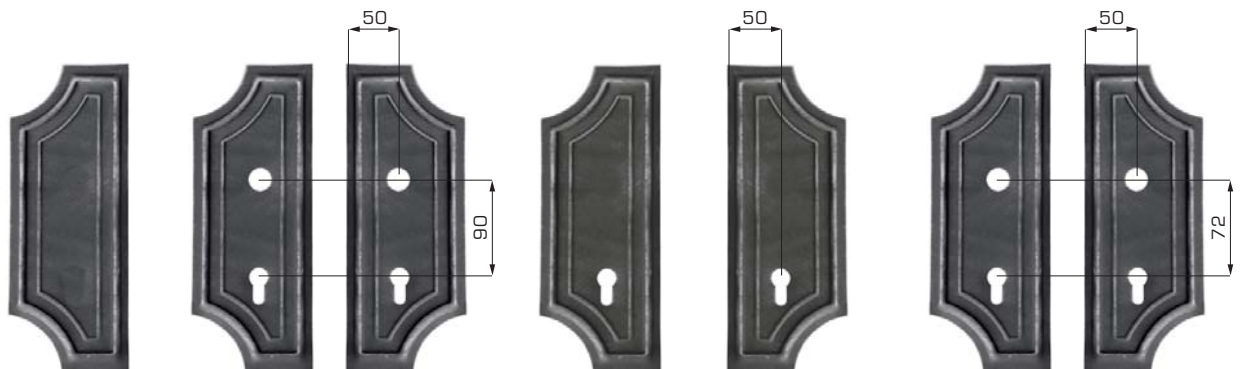

HxL (mm)	280x110	280x110	280x110	280x110	280x110	280x110
	2	2	2	2	2	2
N°	63.129.00.00	63.130.90.50	63.131.90.50	63.130.00.50	63.131.00.50	63.130.72.50

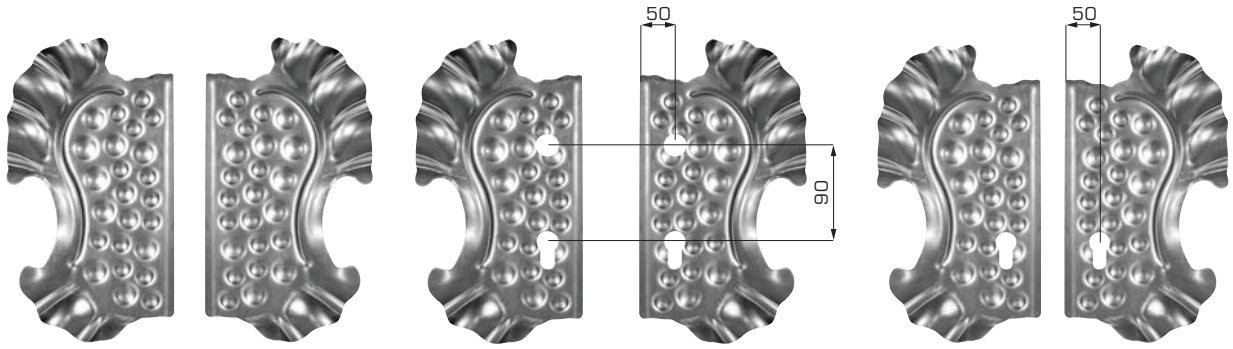

HxL (mm)	290x160	290x160	290x160	290x160	290x160	290x160
	2	2	2	2	2	2
N°	63.134.00.00	63.135.00.00	63.136.90.50	63.137.90.50	63.136.00.50	63.137.00.50

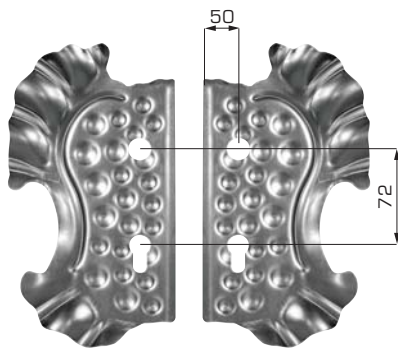

HxL (mm)	230x160	230x160
	2,5	2,5
N°	63.136.72.50	63.137.72.50

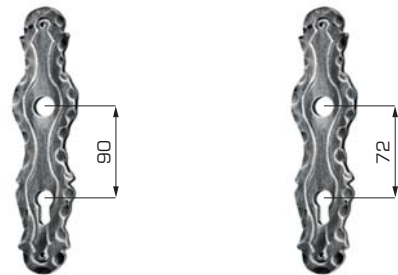

HxL (mm)	260x57	260x57
	3	3
N°	63.138.90.00	63.138.72.00



HxL (mm)	260x52	260x52	260x46	260x46	260x56	260x56	230x40
	3	3	3	3	3	3	5
N°	63.139.90.00	63.139.72.00	63.140.90.00	63.140.72.00	63.141.90.00	63.141.72.00	63.142

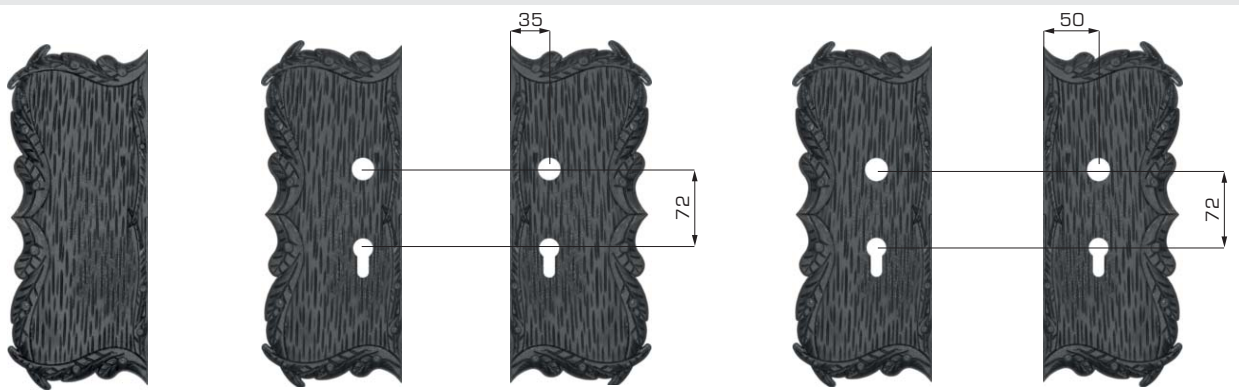

HxL (mm)	310x125	310x125	310x125	310x125	310x125
	2	2	2	2	2
	new	new	new	new	new
N°	63.143.00.00	63.144.72.35	63.145.72.35	63.144.72.50	63.145.72.50

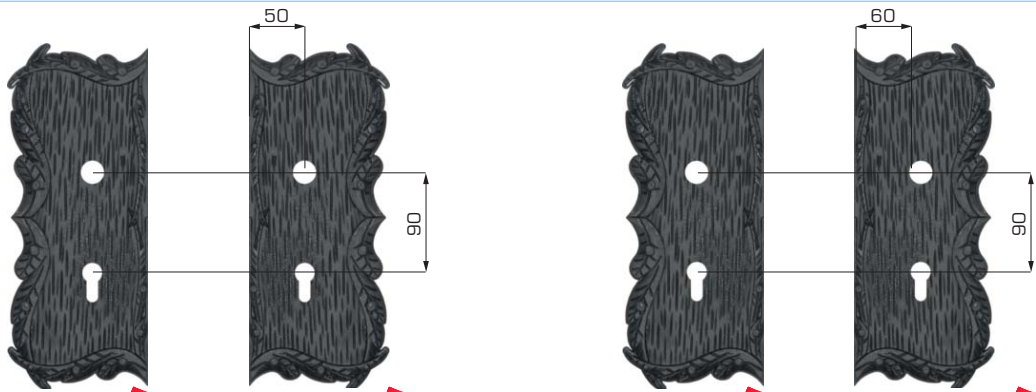

HxL (mm)	310x125	310x125	310x125	310x125
	2	2	2	2
	new	new	new	new
N°	63.144.90.50	63.145.90.50	63.144.90.60	63.145.90.60

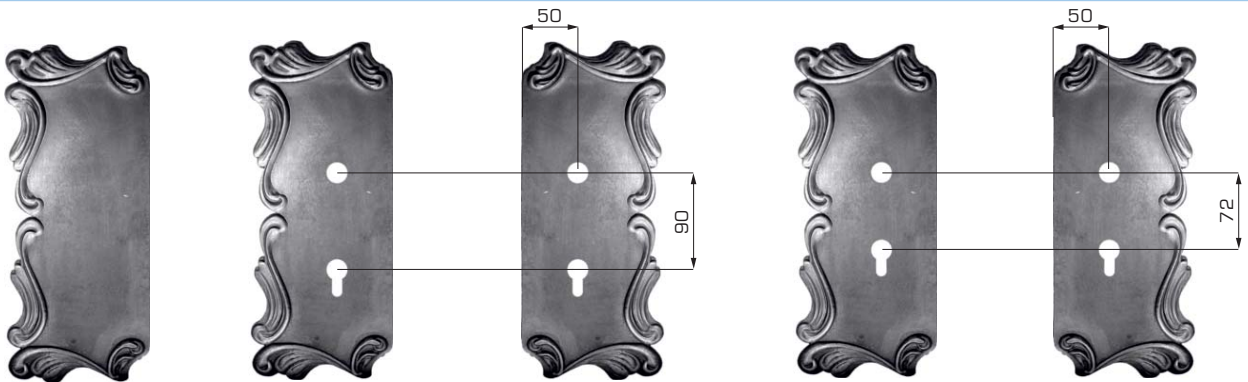

HxL (mm)	315x135	315x135	315x135	315x135	315x135
	3	3	3	3	3
N°	63.146.00.00	63.147.90.50	63.148.90.50	63.149.72.50	63.150.72.50

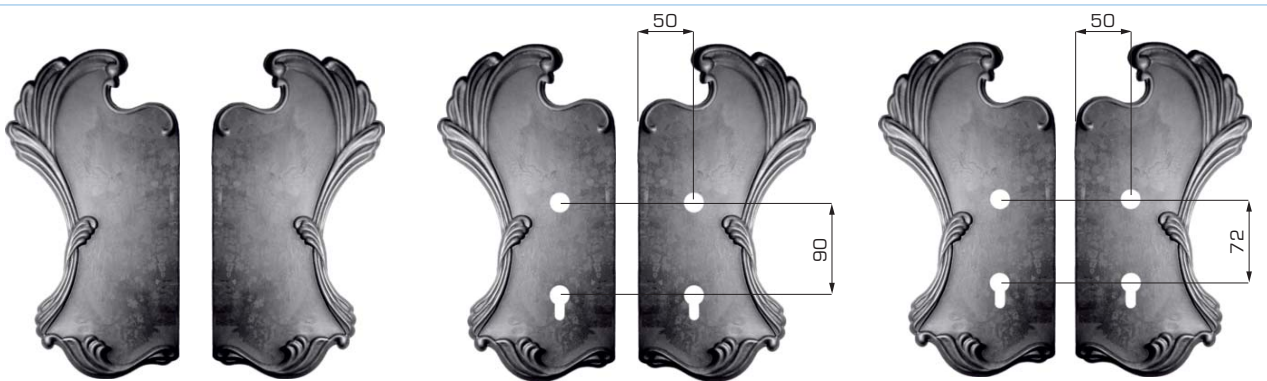

HxL (mm)	330x175	330x175	330x175	330x175	330x175	
	3	3	3	3	3	
N°	63.151.00.00	63.152.00.00	63.153.90.50	63.154.90.50	63.153.72.50	63.154.72.50

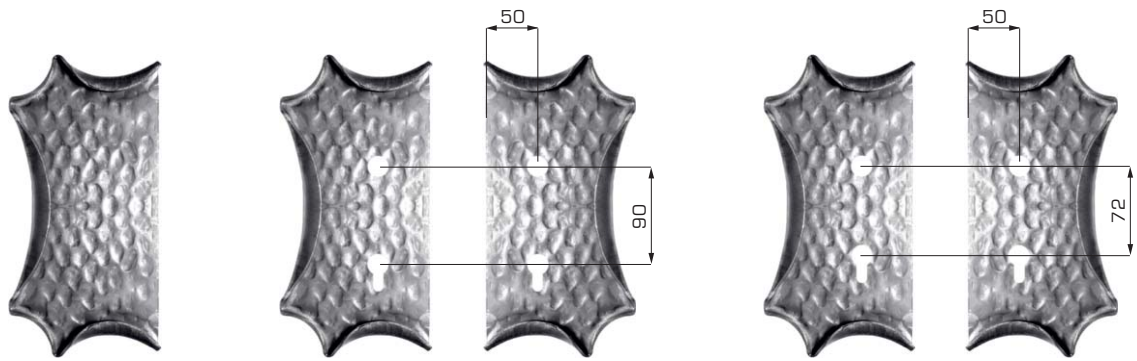

HxL (mm)	280x140	280x140	280x140	280x140	280x140
	4	4	4	4	4
N°	63.157.00.00	63.158.90.50	63.159.90.50	63.158.72.50	63.159.72.50

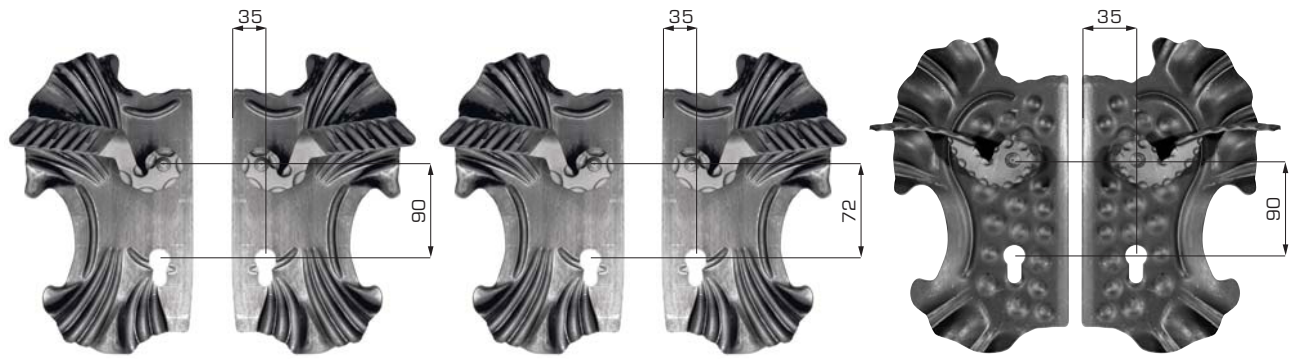

HxL (mm)	285x155	285x155	285x155	285x155	290x160	285x155
	2	2	2	2	2	2
N°	63.171.90.35	63.172.90.35	63.171.72.35	63.172.72.35	63.173.90.35	63.174.90.35

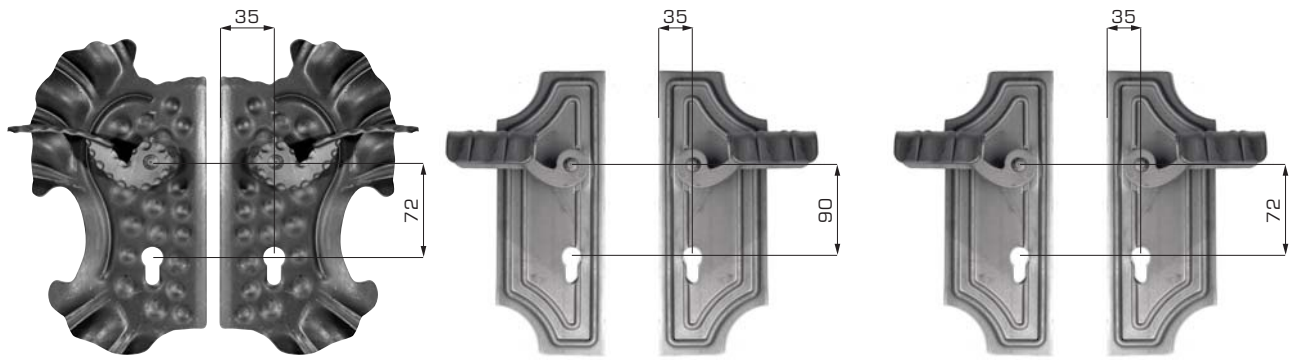

HxL (mm)	290x160	285x155	277x104	277x104	277x104	277x104
	2	2	2	2	2	2
N°	63.173.72.35	63.174.72.35	63.175.90.35	63.175.90.35	63.175.72.35	63.176.72.35

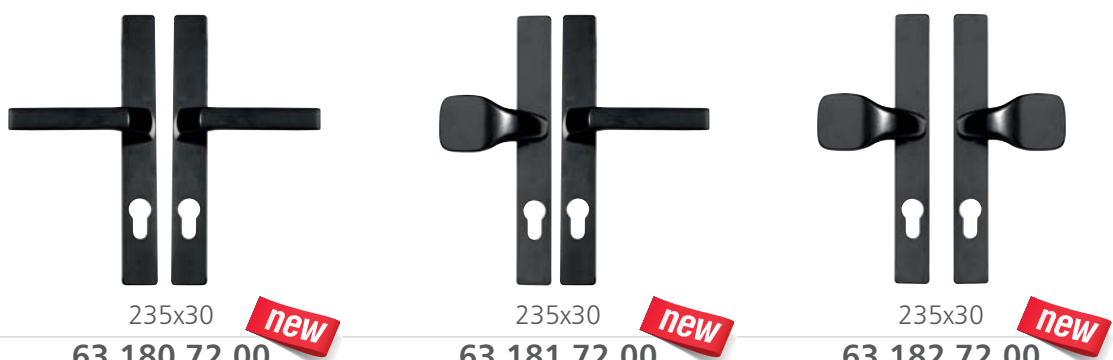

HxL (mm)	235x30	235x30	235x30
N°	63.180.72.00 new	63.181.72.00 new	63.182.72.00 new
HxL (mm)	235x30	235x30	235x30
N°	63.180.90.00 new	63.181.90.00 new	

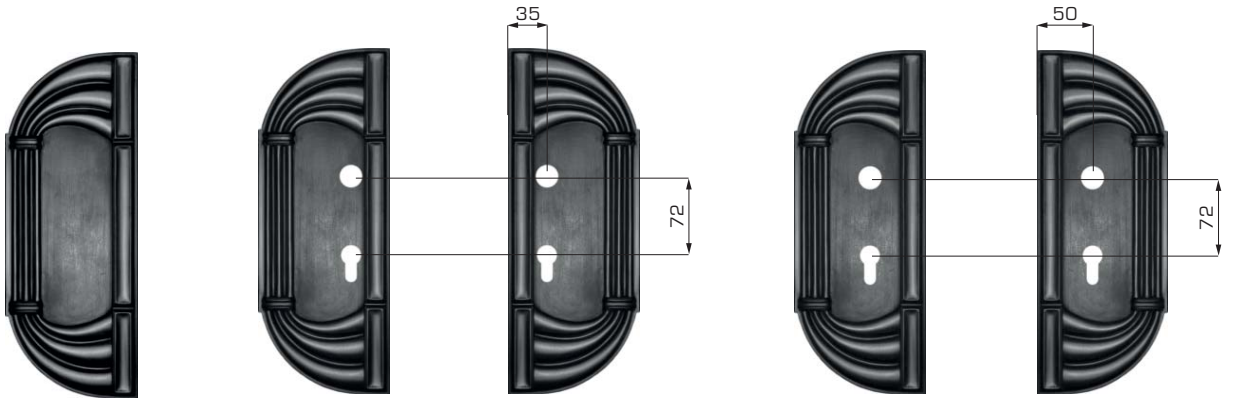

HxL (mm)	310x120	310x120	310x120	310x120	310x120
	2	2	2	2	2
N°	63.185.00.00	63.186.72.35	63.187.72.35	63.186.72.50	63.187.72.50

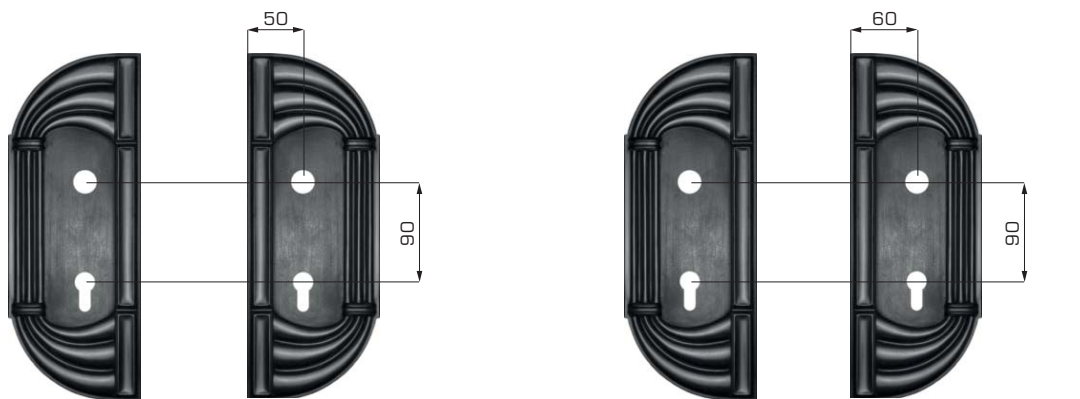

HxL (mm)	310x120	310x120	310x120	310x120
	2	2	2	2
N°	63.186.90.50	63.187.90.50	63.186.90.60	63.187.90.60

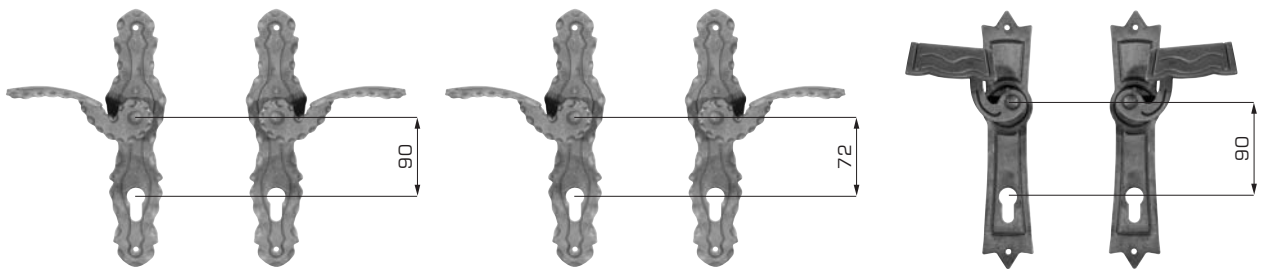

HxL (mm)	260x57	260x57	260x57	260x57	260x52	260x52
	3	3	3	3	3	3
N°	63.191.90.00	63.192.90.00	63.191.72.00	63.192.72.00	63.193.90.00	63.194.90.00

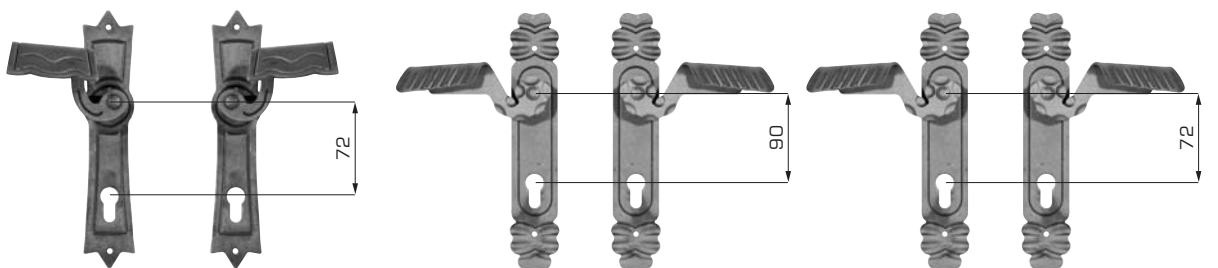

HxL (mm)	260x52	260x52	260x46	260x46	260x46	260x46
	3	3	3	3	3	3
N°	63.193.72.00	63.194.72.00	63.195.90.00	63.196.90.00	63.195.72.00	63.196.72.00

2.04

zamki i wkładki • lock stets and inserts • Türschlösser und Schlosskästen
 • замки и вкладыши • zámky a vložky

locking mechanism with hook and faceplate

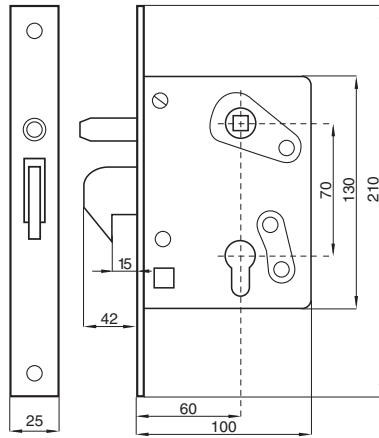

N° 63.200

63.202

locking mechanism with hook and faceplate

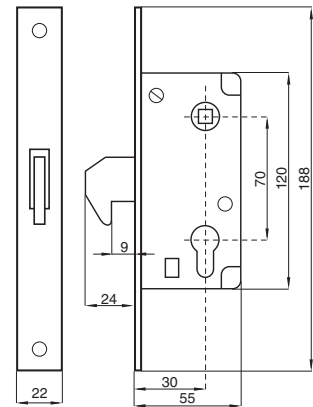
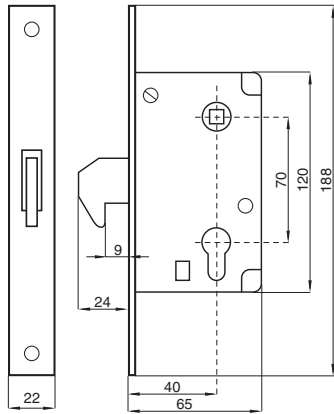

N° 63.204

63.205

locking mechanism with hook and faceplate

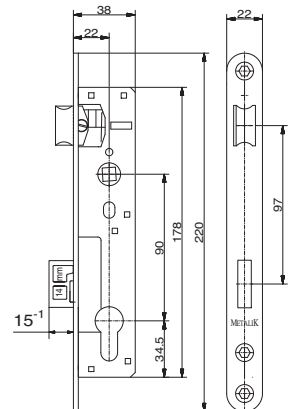
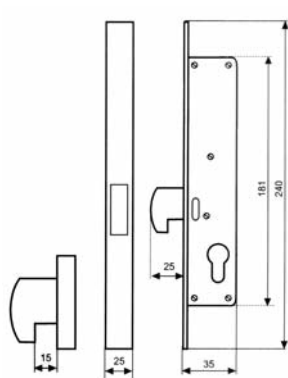
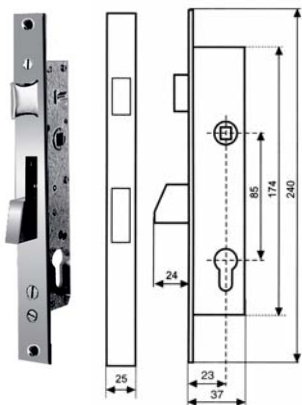

□ N° 63.208

□ 85/20 N° 63.209

90/22 N° 63.210

new

locking mechanism with hook and faceplate

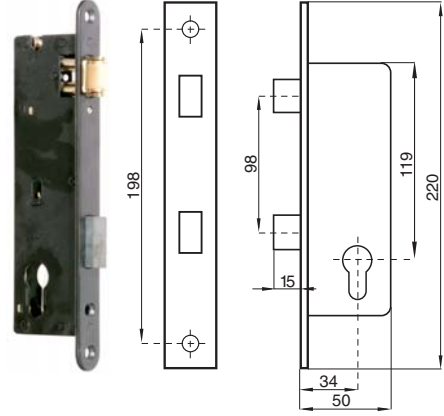
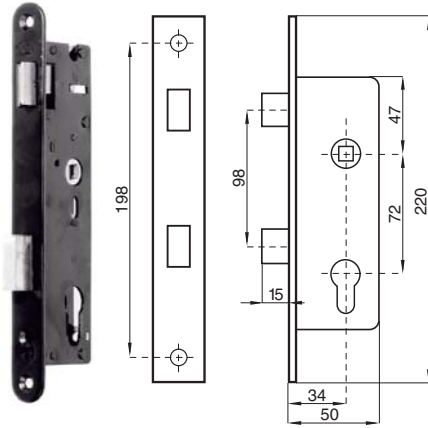

HxL (mm)

72/35

0/35

220

N°

63.211

63.212



HxL (mm)

0/35

0/35

140x50

140x50

100x45

N°

63.213

63.214

63.215



HxL (mm)

72/50

72/50

90/50

90/50

220

155x80x20

220

155x80x20

N°

63.216

63.217

63.218

63.219

door lock set



door lock set



door lock set



door lock set



HxL (mm)	245 / 50x30	245 / 50x30	245 / 50x30	165 / 50x30	165 / 50x30	165 / 50x30
	72/35	72/35	72/35	0/35	0/35	0/35
N°	63.220	63.220.11	63.220.12	63.221	63.221.13	63.221.14

door lock set



door lock set



door lock set



door lock set



HxL (mm)	245 / 60x40	245 / 60x40	245 / 60x40	165 / 60x40	165 / 60x40	165 / 60x40
	72/35	72/35	72/35	0/35	0/35	0/35
N°	63.222	63.222.11	63.222.12	63.223	63.223.13	63.223.14

door lock set



HxL (mm)	260 / 80x40	200x40	260x50	246 / 40x40	246 / 40x40
	90/50			90/22	90/22
N°	63.224	63.225	63.226	63.227	63.228

new

new

new

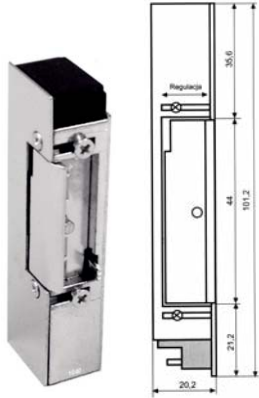

elektrozaczep 12 V z pamięcią
electric lock 12 AC with memory

N° **63.329**

elektrozaczep 12 V
electric lock 12 AC

N° **63.330**



blacha czołowa elektrozaczepu
faceplate for electric lock

N° **63.330.01**



N° **63.330.02**



55x65
N° **63.331**



FC

□	N°
25x25	63.301.01
31x31	63.301.05
36x36	63.301.11



FC, nickel

□	N°
25x25	63.301.02
31x31	63.301.06
36x36	63.301.12

2.05

mocowania i wykończenia • fixings and finishing elements • Aufnahmen und Endstücken
• крепления и отделки • kotvení a zakončení sloupků



HxL (mm) 140x40

8

N° **64.001**



200x65

10

N° **64.002**



50x25

5

N° **64.003**



50x30

6

N° **64.004**



100x25

5

N° **64.005**



100x25

5

N° **64.006**



HxL (mm)	130x25	130x30	420x210	180x95
	Ø12, M10	Ø12, M10	20x20	12x12
N°	64.007	64.008	64.010	64.011

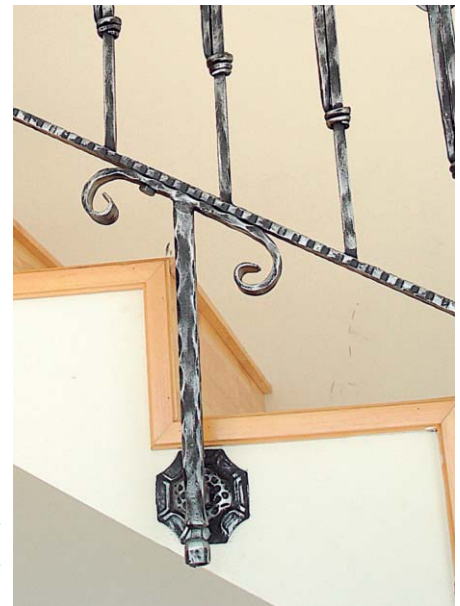

HxL (mm)	180x95	180x95
	12x12	Ø14
N°	64.012	64.013



HxL (mm)	36xØ19	25xØ25	36xØ18	32xØ21	30x19
	Ø6	Ø6	Ø6	Ø10	Ø10
N°	64.020	64.021	64.022	64.023	64.024

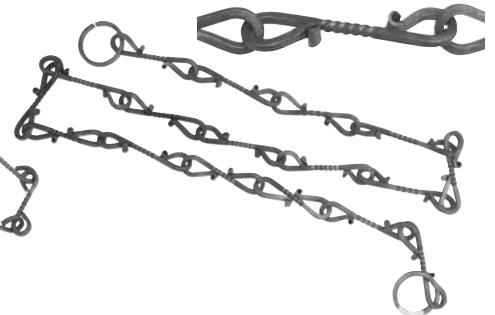
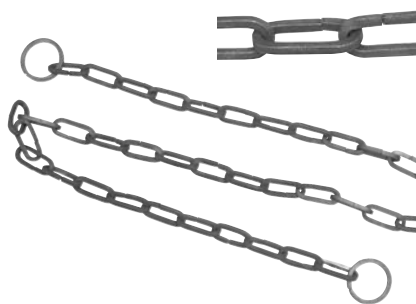

L (mm)	2000	2000	2000
	6x6	6x6	6x6
N°	64.031	64.032	64.033



new

	N°
M8	64.035
M10	64.036
M12	64.037
M14	64.038
M16	64.039



new

	L (mm)	N°
M8	1000	64.040
M10	1000	64.041
M12	1000	64.042
M14	1000	64.043
M16	1000	64.044



new

	L (mm)	N°
M12	300	64.045
M14	300	64.046
M16	300	64.047

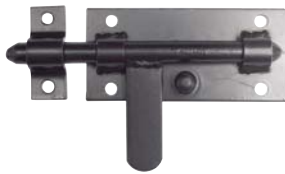

L (mm)	150
	Ø12, ocynk galvanized
N°	64.050



L (mm)	270
	Ø16
N°	64.051



L (mm)	340
	Ø16
N°	64.052



L (mm)	340
	Ø16
N°	64.053



L (mm)	210
	Ø14
N°	64.055



L (mm)	420
	Ø14
N°	64.062



L (mm)	420
	Ø14
N°	64.063

L (mm)	420
	Ø14, ocynk galvanized
N°	64.064

L (mm)	800
	Ø14, ocynk galvanized
N°	64.065



220x12, ocynk galvanized **new**

420x14, ocynk galvanized **new**

N° **64.066**

64.067



Ø16 H300, ocynk galvanized **new**

Ø16 H500, ocynk galvanized **new**

N° **64.069**

64.070



H (mm) 120 120 120 120 120 120 120

N° **64.100 64.101 64.102 64.103 64.104 64.105 64.106**

H (mm) 170 170 170 170 170 170 170

N° **64.100.01 64.101.01 64.102.01 64.103.01 64.104.01 64.105.01 64.106.01**



H (mm) 120 120 120 120 120 120 120

N° **64.107 64.108 64.109 64.110 64.111 64.112 64.113**

H (mm) 170 170 170

N° **64.107.01 64.108.01 64.109.01**

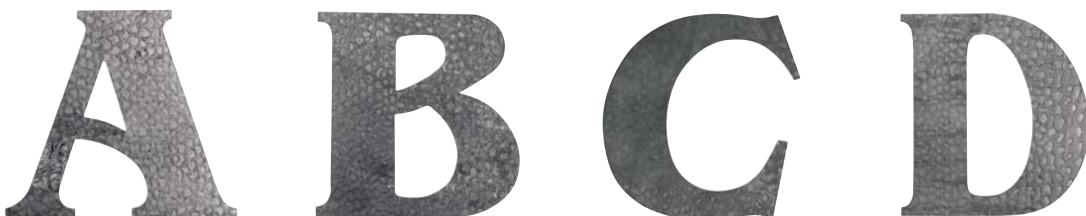

H (mm) 170 170 170 170

N° **64.110.01 64.111.01 64.112.01 64.113.01**



H (mm)	130x115	130x115	155x140
	ocynk galvanized	ocynk galvanized	ocynk galvanized
N°	64.501	64.502	64.503

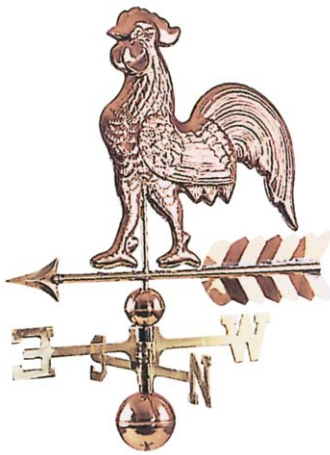

H (mm)	1400	1200
N°	65.001	65.002

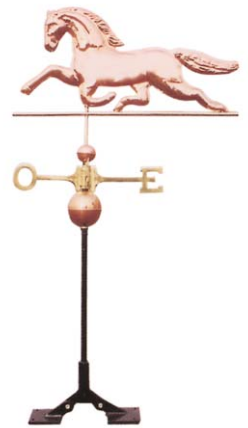

H (mm)	1400	1000
N°	65.003	65.004

2.06 skrzynki • boxes • Kästen • ящики • schránky



HxL (mm)	405x255	405x255	405x255	405x255
	90	90	90	90
N°	65.200	65.201	65.202	65.203



HxL (mm)	445x395	445x395
	170	170
N°	65.210	65.211



HxL (mm)	370x360	470x360x130	370x360
	132	132	132
N°	65.250	65.250.01	65.251



HxL (mm) 370x270 **new**
116
N° 65.252



370x360
132
N° 65.255



350x260 **new**
85
N° 65.256



HxL (mm) 350x260 **new**
85
N° 65.257



405x270 **new**
120
N° 65.259



300x210
65
N° 65.260

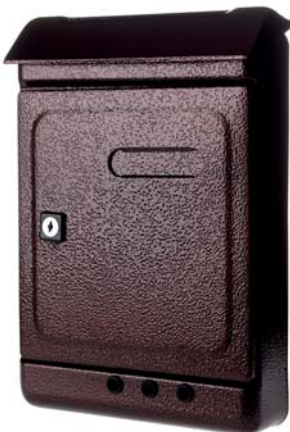

HxL (mm) 300x210
65
N° 65.261



300x210 **new**
65
N° 65.262



360x290 **new**
65
N° 65.270

2.07

lampy • lamps • Lampen • лампы • lampy



Ø290xH 350

N° 66.001



H 530xL 290x330

N° 66.002



H 670xL 310x420

N° 66.003 painted

H 670xL 310x420

N° 66.003.01 galvanized



HxL (mm)

400x300

N° 66.004 painted

400x300

N° 66.004.01 galvanized



380x290

N° 66.006 painted

380x290

N° 66.006.01 galvanized

2.08

farby i patyny • paints and patina • Farben und Edelrost
• краски и патины • barvy a patyny

Farby poliwinylowe • Polyvinyl paints



grafit antyczny
antique graphite

0,8 l

3 l

N° 70.001

N° 70.001.01



czarny antyczny
antique black

0,8 l

3 l

N° 70.002

N° 70.002.01



brąz antyczny
antique brown

0,8 l

3 l

N° 70.003

N° 70.003.01

10 l

new

N° 70.001.02

10 l

new

N° 70.002.02

Farby styrenowo-akrylowe • Styrene-acrylic paints

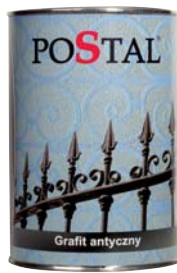

grafit antyczny
antique graphite



czarny antyczny
antique black

	1 l	3 l	10 l new	1 l	3 l	10 l new
N°	70.021	70.021.01	70.021.02	70.022	70.022.01	70.022.02

Patyny poliwinylowe • Polyvinyl patina



patyna złoto
patina gold



patyna srebro
patina silver



patyna miedź
patina copper



patyna zieleń
patina green



patyna jasnozielona
patina light green

	0,23 l	0,23 l	0,23 l	0,23 l	0,23 l new
N°	70.101	70.102	70.103	70.104	70.105



patyna niebieska jasna
patina light blue



patyna czerwona
patina red



patyna żółta
patina yellow



patyna biała
patina white

	0,23 l new	0,23 l new	0,23 l new	0,23 l new
N°	70.106	70.107	70.108	70.109

Patyny styrenowo-akrylowe • Styrene-acrylic patina



patyna złoto
patina gold



patyna srebro
patina silver



patyna miedź
patina copper

	0,23 l	0,23 l	0,23 l
N°	70.121	70.122	70.123

2.09

Kotwy i akcesoria • Anchors and accessories • Anker und Zubehör



new

N° **71.001**



new

300 ml
N° **71.300**



new

410 ml
N° **71.410**



new

□	N°
Ø12x50	74.012
Ø15x85	74.015
Ø15x130	74.015.01
Ø20x85	74.020



new

□	N°
Ø12x1000	74.112
Ø16x1000	74.115
Ø22x1000	74.120



new

□	N°
Ø10	75.010
Ø13	75.013
Ø18	75.018

Pompka do wydmuchiwania zwiercin **new**

N° **75.025**



300 ml **new**

N° **75.030**



380/410 ml **new**

N° **75.041**



380/410 ml **new**

N° **75.041.01**



BOSCH

Technologia bliżej nas

Niemiecka solidność



Elektronarzędzia znanej marki BOSCH

POSTAL STEEL GROUP – autoryzowany dystrybutor BOSCH w Polsce

Szlifierka kąтова



moc 720 W
tarcza Ø125

N° **GWS 7-125 Professional**



1400 W
Ø125

N° **GWS 14-125**



2000 W
Ø230
ograniczenie prądu rozruchu

N° **GWS 20-230**

moc 1000 W
tarcza Ø125

N° **GWS 10-125**

1500 W
Ø125
2 800 – 11 500 obr./min.

N° **GWS 15-125**

2400 W
Ø230
ograniczenie prądu rozruchu

N° **GWS 24-230**

Młot udarowo-obrotowy



720 W, udar 2,4 J
funkcja wiercenia, wiercenia
z udarem, podkuwania
walizka

N° **GBH 2400**

Wiertarka udarowa



750 W, szybkozaciskowy
uchwyt wiertarski
0 – 2 800 obr./min.
walizka

N° **GSB 16 RE**

1 100 W, zębaty uchwyt wiertarski
40/14,5 Nm
0 – 900/3 000 obr./min. 2 biegi
walizka

N° **GSB 21-2 RE**

Wkrętarka udarowa



walizka, 2 aku 1,5Ah

N° **GSB**

walizka L-Boox, 2 aku 4Ah,
szybka ładowarka,
max moment obr. 60 Nm,
uchwyt 13 mm

N° **GSR**

walizka L-Boox, 2 aku 4Ah,
szybka ładowarka,
max moment obr. 75 Nm,
uchwyt 13 mm

N° **GSR 14,4 VE-2-LI**

DEWALT®

Narzędzia, które zbudowały Amerykę

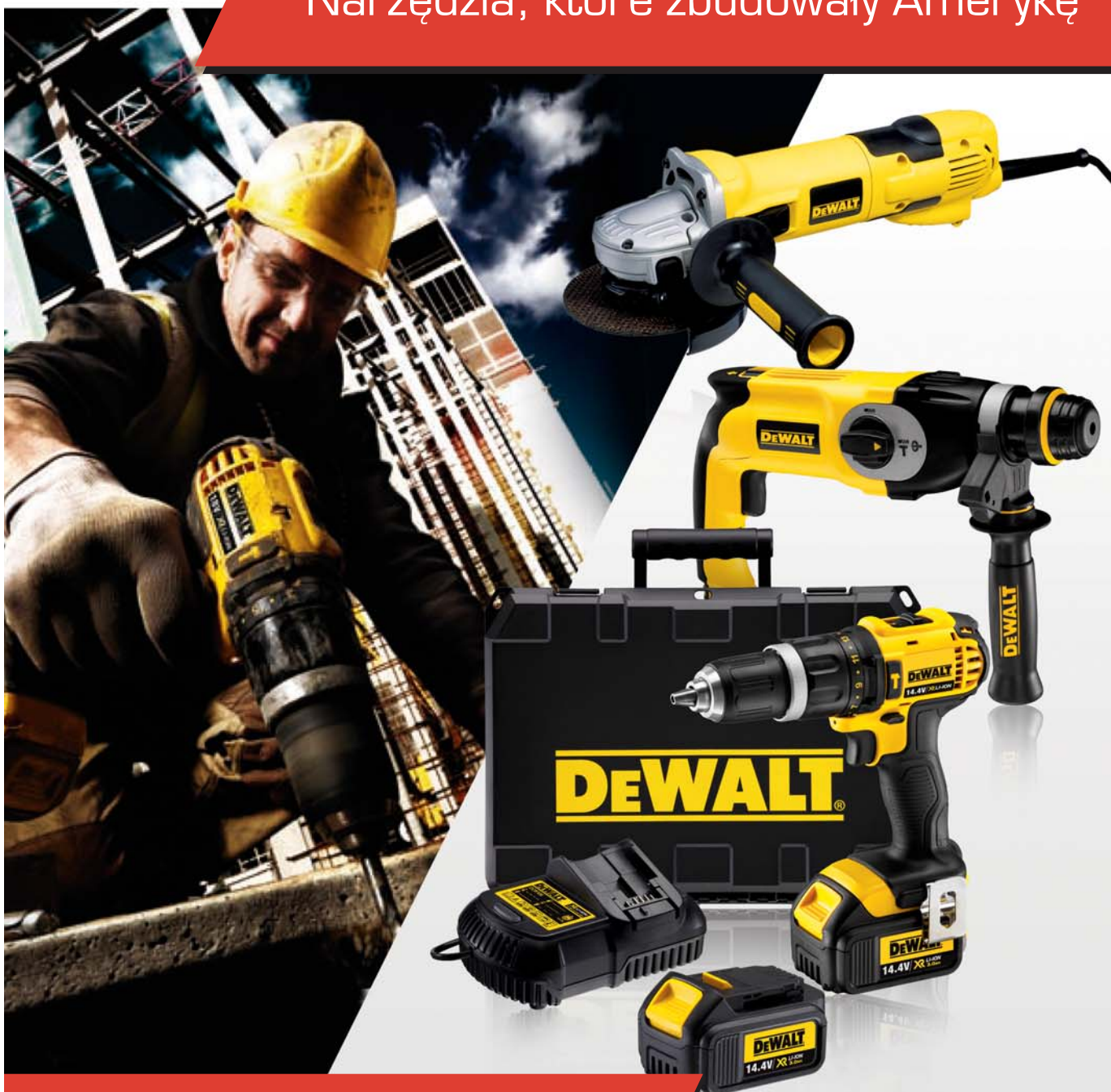

Elektronarzędzia znanej marki DEWALT

Szlifierka kąтова

moc	1200 W	1400 W
tarcza	Ø125	Ø125
gwint wrzeciona	M14	M14
N°	D28132C	D28135

Wiertarko-wkrętarka

moc 180 W
kufer transportowy, 2 aku 4Ah,
prędkość 0-400/1500 obr./min.
max moment obr. 15,8 Nm

N° **DCD710S2**

Wiertarka

moc 310 W
kufer transportowy, 2 aku 4Ah,
prędkość 0-550/2000 obr./min.
częstość uderu 0-9500/33200 ud./min.
uchwyt 13 mm

N° **DCD737D2**



moc 701 W
prędkość 0-2500 obr./min.
uchwyt 10 mm

N° **DWD112S**

Przecinarka ściernicowa do metalu

moc 2200 W
prędkość 3800 obr./min.
średnica koła 355 mm

N° **D28710**







Spawalnictwo

drut spawalniczy, urządzenia
i akcesoria spawalnicze

Platinum

STAR
WIRE

PINOX

ESAB®

Platinumium

Sprawdzony drut spawalniczy
Tested welding wire



Gwarancja jakości

www.drutspawalniczy.pl



grubość thickness	0,8	1,0	1,2
waga weight	15 kg	15 kg	15 kg
ilość na palecie q-ty in package	72 szt. 72 pcs.	72 szt. 72 pcs.	72 szt. 72 pcs.
szpula spool	metal	metal	metal
rodzaj drutu type of wire	G3Si1/SG2	G3Si1/SG2	G3Si1/SG2
kod produktu product code	SP.001.08	SP.002.10	SP.003.12



grubość thickness	0,6	0,8	1,0	1,2
waga weight	5 kg	5 kg	5 kg	5 kg
ilość na palecie q-ty in package	200 szt. 200 pcs.	200 szt. 200 pcs.	200 szt. 200 pcs.	200 szt. 200 pcs.
szpula spool	plastik plastic	plastik plastic	plastik plastic	plastik plastic
rodzaj drutu type of wire	G3Si1/SG2	G3Si1/SG2	G3Si1/SG2	G3Si1/SG2
kod produktu product code	SP.004.06	SP.004.08	SP.005.10	SP.006.12



grubość thickness	1,2
waga weight	15 kg
ilość na palecie q-ty in package	72 szt. 72 pcs.
szpula spool	metal
rodzaj drutu type of wire	G4Si1/SG3
kod produktu product code	SP.010.12

Drut jest zgodny z normą G3Si1, DIN EN ISO 14341-A, SFA/AWS 5.18:ER70S-6 posiada atesty TUV, DB42.142.01, ABS, LR.
 The wire is compliant G3Si1, DIN EN ISO 14341-A, SFA/AWS 5.18:ER70S-6 is certified by TUV, DB42.142.01, ABS, LR.

STAR WIRE

Nowa, jeszcze lepsza jakość
Now, even better quality



Drut spawalniczy do metody MAG do spawania stali nie- i niskostopowych.
Welding wire for MAG welding method of unalloyed and low alloyed steels.

Gwarancja jakości

www.drutspawalniczy.pl



grubość thickness	0,8	1,0	1,2
waga weight	15 kg	15 kg	15 kg
ilość na palecie q-ty in package	72 szt. 72 pcs.	72 szt. 72 pcs.	72 szt. 72 pcs.
szpula spool	metal	metal	metal
rodzaj drutu type of wire	G3Si1/SG2	G3Si1/SG2	G3Si1/SG2
kod produktu product code	SP.001.08X	SP.002.10X	SP.003.12X



grubość thickness	0,6	0,8	1,0	1,2
waga weight	5 kg	5 kg	5 kg	5 kg
ilość na palecie q-ty in package	200 szt. 200 pcs.	200 szt. 200 pcs.	200 szt. 200 pcs.	200 szt. 200 pcs.
szpula spool	plastik plastic	plastik plastic	plastik plastic	plastik plastic
rodzaj drutu type of wire	G3Si1/SG2	G3Si1/SG2	G3Si1/SG2	G3Si1/SG2
kod produktu product code	SP.004.06X	SP.004.08X	SP.005.10X	SP.006.12X



grubość thickness	1,2
waga weight	15 kg
ilość na palecie q-ty in package	72 szt. 72 pcs.
szpula spool	metal
rodzaj drutu type of wire	G4Si1/SG3
kod produktu product code	SP.010.12X

Drut jest zgodny z normą G3Si1, DIN EN ISO 14341-A, SFA/AWS 5.18:ER70S-6 posiada atesty TUV, DB42.142.01, ABS, LR.
The wire is compliant G3Si1, DIN EN ISO 14341-A, SFA/AWS 5.18:ER70S-6 is certified by TUV, DB42.142.01, ABS, LR.



drut spawalniczy
do stali nierdzewnej



Do metody MIG MAG – na rolce metalowej

rodzaj	grubość	waga	N°
308L	0,8 mm	15 kg	SPM.308.08.15
308L	1,0 mm	15 kg	SPM.308.10.15
308L	1,2 mm	15 kg	SPM.308.12.15
316L	0,8 mm	15 kg	SPM.316.08.15
316L	1,0 mm	15 kg	SPM.316.10.15

Do metody TIG – w formie prętów

rodzaj	grubość	długość	waga	N°
308L	1,2 mm	1000 mm	5 kg	SPT.308.12.05
308L	1,6 mm	1000 mm	5 kg	SPT.308.16.05
308L	2,0 mm	1000 mm	5 kg	SPT.308.20.05
308L	2,4 mm	1000 mm	5 kg	SPT.308.24.05
316L	1,2 mm	1000 mm	5 kg	SPT.316.12.05
316L	1,6 mm	1000 mm	5 kg	SPT.316.16.05
316L	2,0 mm	1000 mm	5 kg	SPT.316.20.05
316L	2,4 mm	1000 mm	5 kg	SPT.316.24.05



Stosowany w automatach MIG/MAG oraz TIG.

Aksesoria spawalnicze MIG/MAG

W celu łatwego odszukania produktu, numery kodów akcesoriów spawalniczych są zgodne ze standardem oznaczeń występującym w branży.



Dysze gazowe • Gass nozzle

typ	15 AK	25 AK	24 KD	36 KD	401 D / 501 D
Ø	Ø 12	Ø 15	Ø 12,5	Ø 15	Ø 16
rodzaj	stożkowa	stożkowa	stożkowa	stożkowa	stożkowa
N°	SPA.145.0075	SPA.145.0076	SPA.145.0080	SPA.145.0078	SPA.145.0085

Dysze prądowe • Contact tip

	typ	Ø	materiał	N°
	15 AK	Ø 0,6	M6*25 E-Cu	SPA.140.0008
	15 AK	Ø 0,8	M6*25 E-Cu	SPA.140.0059
	15 AK	Ø 1,0	M6*25 E-Cu	SPA.140.0253
	15 AK	Ø 1,2	M6*25 E-Cu	SPA.140.0387
	25 AK	Ø 0,8	M6*28 E-Cu	SPA.140.0051
	25 AK	Ø 1,0	M6*28 E-Cu	SPA.140.0242
	25 AK	Ø 1,2	M6*28 E-Cu	SPA.140.0379
	25 AK	Ø 0,8	M6*28 CuCrZr	SPA.140.0054
	25 AK	Ø 1,0	M6*28 CuCrZr	SPA.140.0245
	25 AK	Ø 1,2	M6*28 CuCrZr	SPA.140.0382
	36 KD	Ø 0,8	M8*30 E-Cu	SPA.140.0114
	36 KD	Ø 1,0	M8*30 E-Cu	SPA.140.0313
	36 KD	Ø 1,2	M8*30 E-Cu	SPA.140.0442
	36 KD	Ø 1,6	M8*30 E-Cu	SPA.140.0587
	36 KD	Ø 1,2	M8*30 E-Cu do Al	SPA.140.0015
	36 KD	Ø 1,2	M8*30 CuCrZr	SPA.140.0445
	36 KD	Ø 1,6	M8*30 CuCrZr	SPA.140.0587
	401D/501D	Ø 1,6	M8*30 CuCrZr	SPA.140.0590

Sprężyna dyszy • Nozzle spring

N°	SPA.002.0058	SPA.003.0013

Łącznik dyszy gazowej / Łącznik prądowy Gas nozzle holder / Contact tip holder

N°	SPA.002.0078 L

N°	SPA.142.0001

Uchwyt • Grip

	nylonowy
N°	SPA.GRIP 501

Łącznik prądowy • Contact tip holder

typ	24 KD	36 KD	401 D/501 D
	M6	M8	M8
N°	SPA.142.0003	SPA.142.0020	SPA.142.0022

Rozdzielacz gazu (tulejka izolacyjna) • Gas diffuser

typ	24 KD	36 KD	401 D/501 D
	standardowy	ceramiczny	standardowy
N°	SPA.012.0183	SPA.014.0023	SPA.030.0145



Urządzenia i materiały spawalnicze marki ESAB



Skontaktuj się z Opiekunem POSTAL



MIG/MAG kompakt 400V
Origo Mig C280 PRO, C280 PRO 4WD,
C340 PRO 4WD

Profesjonalne półautomaty spawalnicze o wytrzymałej obudowie odpornej na uszkodzenia mechaniczne. Możliwość zamontowania filtra powietrza oraz stopień ochrony IP23 gwarantuje bezpieczną pracę w trudnych warunkach przemysłowych. Urządzenia przeznaczone są do spawania stali niskowęglowej, wysokostopowej i aluminium drutami o średnicy 0,8 – 1,2 mm. Wielozakresowa regulacja napięcia i zmiana indukcyjności, pozwala osiągać stabilne jarzenie się łuku. Wersja 4WD posiada 4-rolkowy układ podawania spoiwa.

Podstawowe funkcje sterowania:

- Origo Mig C280 – spawanie punktowe, miernik V/A (opcja)
- Origo Mig C340 – obniżona prędkość dojazdu, 2/4 takt, miernik V/A, regulacja długości upalania elektrody (drutu).



TIG/MMA AC/DC – inwertor 230V
Caddy Tig 2200i AC/DC panel TA33 I TA34

Inwertorowe urządzenie do spawania metodą TIG i MMA prądem stałym i przemiennym (AC/DC), które zasilane są z sieci 230V. System PFC, efektywnie wykorzystuje energię z sieci oraz chroni przed nadmiernymi spadkami napięcia zasilającego szczególnie przy zasilaniu z generatorów prądowych. Niewielka i lekka kompaktowa obudowa przystosowana jest do zamontowania dodatkowej chłodnicy Cool Mini. Urządzenia wyposażone są w innowacyjne funkcje sterowania – QWave, funkcja stabilizująca proces spawania aluminium i jego stopów prądem przemiennym AC, umożliwia spawanie bez układu HF. Funkcja True AC Rating pozwala na spawanie rzeczywistym prądem, który został wcześniej ustawiony na panelu sterowania bez względu na długość uchwyty TIG. Urządzenia mogą być wyposażone w dwa panele sterowania TA33 i TA34.

Elektroda ER 146

Średniootulona elektroda z dodatkiem celulozy w otulinie, do spawania konstrukcji stalowych narażonych na obciążenia statyczne i dynamiczne (konstrukcje okrętowe, budowlane, tabor komunikacyjny itp.), zalecana do prac montażowych.

Elektroda EB 150

Grubootulona elektroda do spawania konstrukcji ze stali o podwyższonej wytrzymałości ($Re \leq 420$ MPa) narażonych na duże obciążenia statyczne i dynamiczne (konstrukcje okrętowe, tabor komunikacyjny, maszyny budowlane itp.) Umożliwia wykonywanie spoin pachwinowych w pozycji pionowej z góry na dół.





Caddy Arc 251i panel A32, A34

Wysokowydajne urządzenie do spawania metodą MMA oraz TIG o znamionowym prądzie 250A i zasilaniu z sieci 400V. Istnieje również możliwość spawania metodą MAG przy zastosowaniu specjalnego podajnika MobileFeed 300. Blok mocy oparty jest na najnowszej technologii inwerterowej, który umożliwia spawanie wszystkimi typami elektrod otulonych o średnicy od 1,6- 5,0 mm. Automatyczne funkcje sterowania procesem MMA pozwalają na bezproblemowe spawanie we wszystkich warunkach środowiskowych również na zewnątrz. Urządzenia posiadają dwa panele sterowania A32 lub A34. Unikalną funkcją jest linia syngeryczna w procesie MMA, która pozwala optymalnie dobrać parametry spawania dla różnych typów elektrod otulonych (rutylowa, zasadowa oraz celulozowa).



Przecinarki plazmowe inwerter 400V Power Cut 900,1600

Nowej generacji inwerterowe wysokowydajne przecinarki plazmowe o wytrzymałej niewielkiej obudowie, przeznaczone są do cięcia metali, które przewodzą prąd elektryczny. Urządzenia przystosowane są również do żłobienia z usuwaniem materiału do 7,6 kg/h. Prosta oraz intuicyjna nastawa parametrów cięcia przy zastosowaniu sprężonego powietrza lub azotu, pozwala uzyskać wysoką jakość wykonywanych prac na stanowiskach ręcznych oraz zmechanizowanych. Blowback – technologia zajarzania łuku bez udziału wysokiej częstotliwości. Inicjacja łuku pilotującego sterowana jest poprzez odpowiednie układy elektroniczne i pneumatyczne. Auto-modes – automatyczna funkcja, która przełącza poszczególne charakterystyki w trybie cięcia ciągłego, przerywanego oraz żłobienia. Gouging capability – funkcja która dostarcza optymalne parametry napięciowo-prądowe w procesie żłobienia plazmowego.



Maska WARRIOR TECH 9-13

- zakres stopni zaciemnienia: 9 – 13 DIN
- ilość czujników: 4
- czas przełączania: 0,3 ms
- czas reakcji przy rozjaśnianiu: 0,1 – 1,0 s
- stopień zaciemnienia w stanie jasnym: 4DIN
- pole widzenia: 98 x 48 mm
- zasilanie: fotoogniwo
- waga: 520 g

Tarcze do cięcia i szlifowania stali



**STAR
FLEX**



STAR FLEX

więcej niż tarcze
more than discs



Aby uzyskać
więcej informacji
skontaktuj się
ze swoim
opiekunem

Tarcze STAR FLEX do cięcia i szlifowania stali

Zapewniają podwyższoną twardość tarcz do cięcia stali nierdzewnej. Charakteryzują się wysoką wydajnością i długim okresem trwałości.

STAR FLEX blades for cutting and grinding

Provide increased hardness of stainless steel blades. Characterized by high efficiency and long shelf life.

www.starflex.pl



wymiary size	ilość w opak. q-ty in package	N°
115 x 1,0 x 22	100, 600	TCI 115 10 22
125 x 1,0 x 22	100, 600	TCI 125 10 22
125 x 1,6 x 22	100, 600	TCI 125 16 22
125 x 2,5 x 22	50, 200	TCI 125 25 22
180 x 2,0 x 22	50, 200	TCI 180 20 22 new
230 x 2,0 x 22	50, 100	TCI 230 20 22
230 x 3,0 x 22	50, 100	TCI 230 30 22



wymiary size	ilość w opak. q-ty in package	N°
300 x 3,0 x 32	25	TCI 300 30 32
350 x 3,5 x 32	25	TCI 350 35 32
400 x 4,0 x 32	25	TCI 400 40 32



wymiary size	ilość w opak. q-ty in package	N°
115 x 6,0 x 22	25, 100	TZI 115 60 22
125 x 6,0 x 22	25, 100	TZI 125 60 22
180 x 6,0 x 22	25, 100	TZI 180 60 22 new
230 x 6,0 x 22	25, 50	TZI 230 60 22



wymiary size	ilość w opak. q-ty in package	N°
125 x 22 x 40	10, 200	TLI 125 22 40
125 x 22 x 60	10, 200	TLI 125 22 60
125 x 22 x 80	10, 200	TLI 125 22 80



wymiary size	ilość w opak. q-ty in package	N°
125 x 22 x 40	10, 200	TLS 125 22 40 new
125 x 22 x 60	10, 200	TLS 125 22 60 new
125 x 22 x 80	10, 200	TLS 125 22 80 new

data przydatności

kod produktu

średnica tarczy x grubość x średnica otworu

oznakowanie dot. bezpieczeństwa

Wskazówki dotyczące użycia:

- przestrzegać wskazówek dot. bezpieczeństwa
- nosić okulary ochronne
- chronić słuch
- pracować w rękawiczkach
- zakładać maskę antypyłową

kolorowy pasek wg normy EN

specyfikacja techniczna:

- WA - korund biały
- 60 - wielkość ziarna
- T - stopień twardości (bardzo twarde)
- BF - spoiwo żywic syntetycznych wzmocnione włóknem

max. prędkość obrotowa (m/s)

grupa materiałów: stal i stal nierdzewna

kod kreskowy

tarcze do cięcia i szlifowania

PFERD

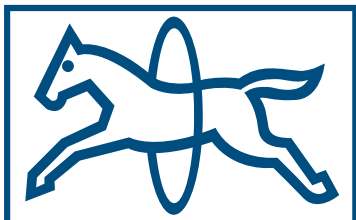

160 lat tradycji



Narzędzia i materiały ściernie
wysokiej jakości.

Skontaktuj się z Opiekunem POSTAL

POSTAL STEEL GROUP – autoryzowany dystrybutor tarcz renomowanej marki Pferd

Automatyka do bram renomowanych marek



FAAC

5.01

automatyka do bram • gate automation systems • Torautomatik
 • автоматика для ворот • automatické pohony bran

Kompletne zestawy do zautomatyzowania bram dwuskrzydłowych o długości jednego skrzydła do 3 m



Zestaw KRONO STANDARD

- 230 V prawostronny siłownik
- 230 V lewostronny siłownik
- centrala sterująca
- karta częstotliwości
- pilot
- fotokomórki

Zestaw KRONO PLUS

- 230 V prawostronny siłownik z wyłącznikami krańcowymi
- 230 V lewostronny siłownik z wyłącznikami krańcowymi
- centrala sterująca
- karta częstotliwości
- pilot
- fotokomórki

Kompletny zestaw do zautomatyzowania bram dwuskrzydłowych o długości jednego skrzydła do 2,3 m. Automatyka szybka w montażu.



Zestaw FAST PLUS

- 230 V siłownik z wbudowaną płytą ZF1
- 230 V siłownik
- karta częstotliwości
- pilot
- fotokomórki

Zestaw do zautomatyzowania bram dwuskrzydłowych całkowicie niewidoczny



Zestaw FROG

- 2x 230 V siłownik
- 2x obudowa podziemna
- 2x system wysprzęglający
- centrala sterująca
- karta częstotliwości
- pilot
- fotokomórki

Kompletne zestawy do zautomatyzowania bram przesuwnych do masy 400 kg i 800 kg

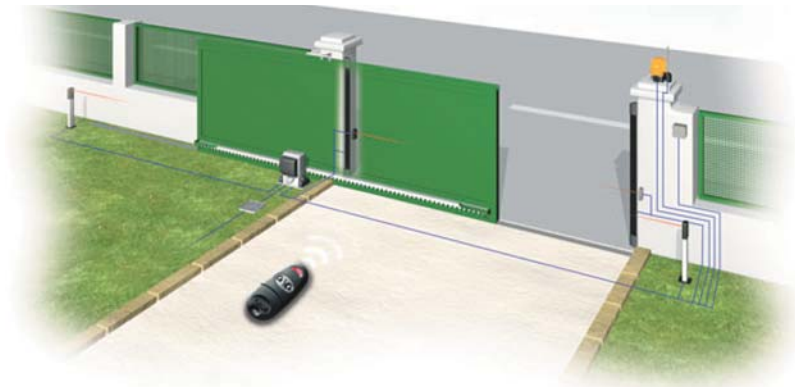

Zestaw BX PLUS – do 400 kg

- 230 V siłownik z wbudowaną płytą sterującą
- karta częstotliwości
- pilot
- fotokomórki

Zestaw BX STRONG – do 800 kg

- 230 V siłownik z wbudowaną płytą sterującą
- karta częstotliwości
- pilot
- fotokomórki

Zestawy do zautomatyzowania uchylnych i segmentowych bram garażowych nie zawierają szyny prznoszącej napęd

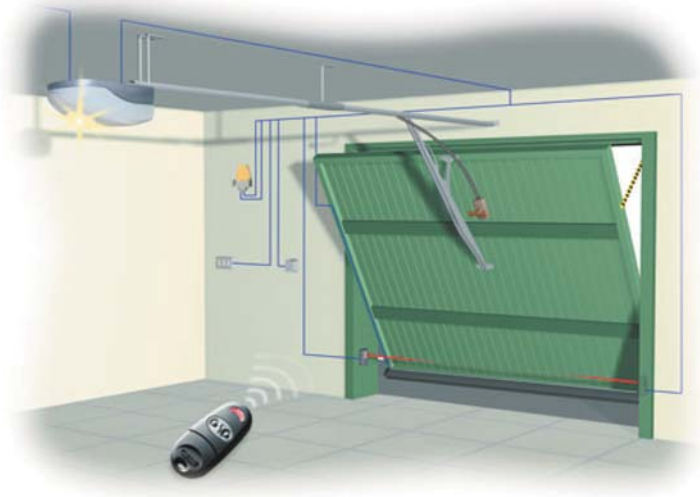

Zestaw VER 900E – siła ciągu 500 N

- 24 V siłownik z enkoderem
- karta częstotliwości
- pilot

Zestaw VER 700E – siła ciągu 850 N

- 24 V siłownik z enkoderem
- karta częstotliwości
- pilot

Szlaban automatyczny do 2,5 m

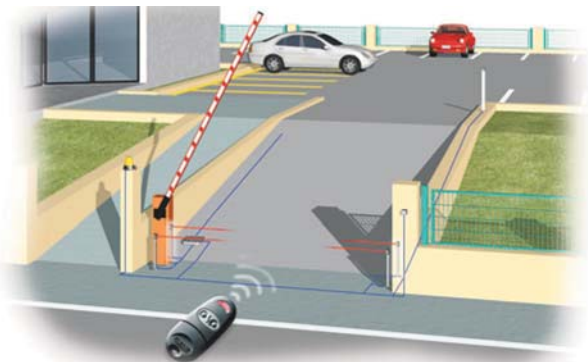

Zestaw GARD

- 230 V szlaban z wbudowaną centralą sterującą
- ramię aluminiowe płaskie
- naklejki odbłaskowe
- karta częstotliwości
- pilot
- fotokomórki

automatyka do bram

Nowoczesne piloty

433,92 MHz



Pilot SPACE SP2

pilot dwukanałowy zmiennokodowy

Pilot SPACE SP4

pilot czterokanałowy zmiennokodowy

Antena radiowa



Antena TOP

433,92 MHz

Lampa ostrzegawcza



Lampa KIARO

230 V

Szyna z łańcuchem do bram uchylnych i segmentowych

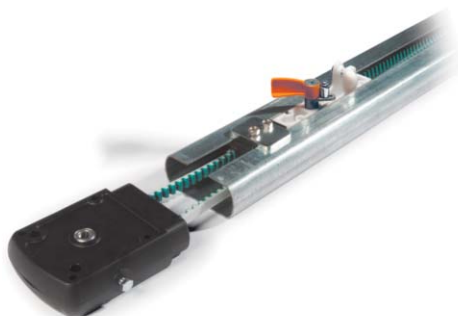

Szyna z łańcuchem VO679

- długość łańcucha 3,02 m
- do bram uchylnych o wysokości do 2,4 m
- do bram segmentowych o wysokości 2,25 m

Szyna z łańcuchem VO682

- długość łańcucha 3,52 m
- do bram uchylnych o wysokości do 2,9 m
- do bram segmentowych o wysokości 2,75 m

Napęd elektromechaniczny
do przesuwnych bram
do masy 500 kg i 900 kg

FAAC



Model 740

- maksymalny ciężar skrzydła: 500 kg
- częstotliwość użytkowania: 30 %
- centrala sterująca w komplecie



Model 741

- maksymalny ciężar skrzydła: 900 kg
- częstotliwość użytkowania: 40 %
- centrala sterująca w komplecie

Napęd elektromechaniczny
do uchylnych i segmentowych
bram garażowych
z jednoczęściową szyną jezdnią

FAAC



Model D600

- centrala sterująca
- częstotliwość użytkowania: 20 cykle/godz.
- maksymalne wymiary bramy:
szerokość 3 m x wysokość 3,10 m



Model D1000

- centrala sterująca
- częstotliwość użytkowania: 20 cykle/godz.
- maksymalne wymiary bramy:
szerokość 5 m x wysokość 3,80 m

Zestaw
napędu elektromechanicznego
do bram dwuskrzydłowych
z zamkiem elektromagnetycznym

FAAC



Zestaw 414

- siłownik samoblokujący prawy do skrzydła o długości 4 m
- siłownik samoblokujący lewy do skrzydła o długości 4 m
- częstotliwość użytkowania: 20 cykle/godz.



Zestaw 414 (fix3)

- siłownik samoblokujący prawy do skrzydła o długości 6 m
- siłownik samoblokujący lewy do skrzydła o długości 6 m
- częstotliwość użytkowania: 20 cykle/godz.

automatyka do bram

Zestaw napędu elektromechanicznego do bram przesuwnych do masy 400 kg

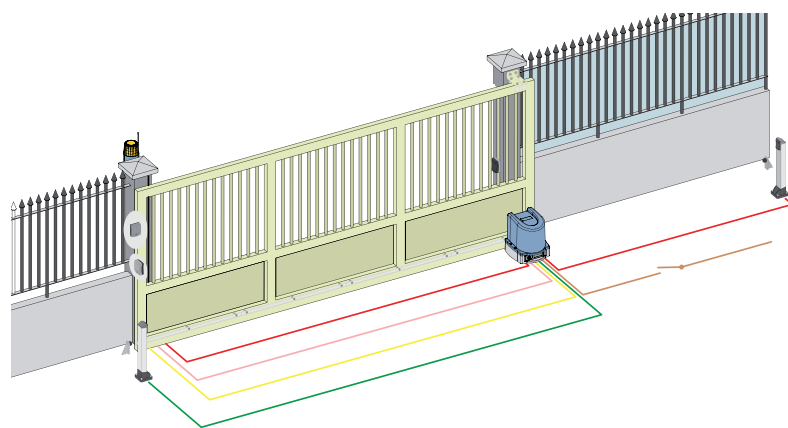

Zestaw Milord

- maksymalny ciężar skrzydła: 400 kg
- częstotliwość użytkowania: 30 %
- centrala sterująca w komplecie

Zestaw napędu elektromechanicznego do bram dwuskrzydłowych o długości jednego skrzydła do 3 m i 4 m



Zestaw G-Bat 300 – do 3 m

- siłownik samoblokujący prawy do skrzydła o długości 3 m
- siłownik samoblokujący lewy do skrzydła o długości 3 m
- częstotliwość użytkowania: 30 %

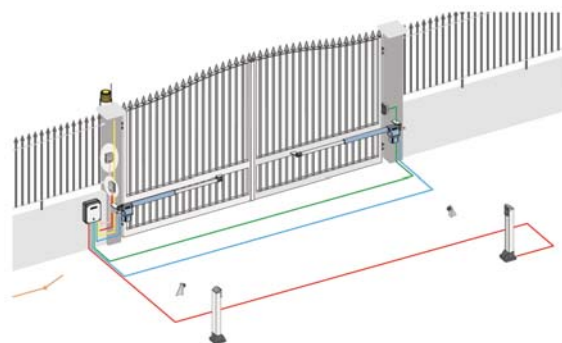

Zestaw G-Bat 400 – do 4 m

- siłownik samoblokujący prawy do skrzydła o długości 4 m
- siłownik samoblokujący lewy do skrzydła o długości 4 m
- częstotliwość użytkowania: 30 %

Lampa ostrzegawcza

FAAC



Lampa FAACLIGHT

- 230 V, 40 W

Antena radiowa

FAAC



Antena AE2

- 433,92 MHz
- długość kabla 2,5 m

Antena AE4

- 433,92 MHz
- długość kabla 4,5 m